

Adaptors



ADAPTORS
DISCLAIMER
Disclaimer

The information and dimensions listed in these catalogues is correct to the best of our knowledge and belief, having been compiled from reliable and official sources of information. However Hardy Spicer (HS Company Pty Ltd) accepts no responsibility for possible errors, omissions or unsuitable parts being listed or fitted to any vehicle. Dimensions listed are nominal throughout.

Due to our continuous product and range development we reserve the right to alter the specification without prior notice.

We welcome any feedback re suspected errors or omissions to the information enclosed. We can be contacted via email hspicer@hardyspicer.com.au

Or via Ph 03 9794 1900 or Fax 03 97069928

Alternatively via mail at PO Box 4262, Dandenong South, Vic. 3164.

Adaptors

www.hardyspicer.com.au

Document No:	HSHYDCAT
Issue:	9
Issue Date:	01/04/12

ADAPTORS

SECTION 5

ADAPTOR CODES

STRAIGHT MALE/FEMALE ADAPTORS.....	1
45° MALE/FEMALE.....	4
90° MALE/FEMALE.....	9
T PIECES MALE/FEMALE.....	5
BULKHEAD STRAIGHT.....	10
BULKHEAD 90°.....	90
TUBE WELD NIPPLES - FLANGES.....	25

DESCRIPTION	PART NO.	PAGE
-------------	----------	------

STRAIGHT ADAPTORS

BSPP x BSPP NIPPLE.....	P1M.....	D:5-4
BSPP x JIC NIPPLE.....	JP1M.....	D:5-5
BSPT x BSPT NIPPLE.....	B1M.....	D:5-6
METRIC x JIC NIPPLE.....	JM1M.....	D:5-7
BSPP x BSPT NIPPLE.....	BP1M.....	D:5-8
BSPT x BSPP M/F UNION.....	B1MFS.....	D:5-8
UN 'O' RING x BSP M/F ADAPTOR.....	UB1MF.....	D:5-9
BSPP x JIC M/F ADAPTOR.....	PJ1MFS.....	D:5-9
NPT x JIC NIPPLE.....	JN1M.....	D:5-10
BSPT x JIC NIPPLE.....	JB1M.....	D:5-11
JIC x JIC NIPPLE.....	J1M.....	D:5-12
BSPT x JIC M/F FIXED UNION.....	BJ1MF.....	D:5-12
UN 'O' RING x JIC NIPPLE.....	JU1M.....	D:5-13
UN 'O' RING x LP HOSE TAIL.....	UH1M.....	D:5-14
BSPT x LP HOSE TAIL.....	BH1M.....	D:5-14
JIC x JIC BULKHEAD NIPPLE.....	J10M.....	D:5-15
BSPP BULKHEAD NIPPLE.....	B10M.....	D:5-15
UN 'O' RING x BSPT NIPPLE.....	BU1M.....	D:5-16
NPT x NPT NIPPLE.....	N1M.....	D:5-17
O' RING FACE SEAL x BSPT NIPPLE.....	OB1M.....	D:5-17
O' RING FACE SEAL x UNO 'O' RING.....	OU1M.....	D:5-18
O' RING FACE SEAL x 'O' RING FACE SEAL.....	O1M.....	D:5-18

45° ADAPTORS

BSPT x BSPT 45° ELBOW.....	B4M.....	D:5-18
BSPT x BSPP M/F 45° ELBOW.....	B4MFS.....	D:5-19
BSPT x JIC 45° ELBOW.....	JB4M.....	D:5-19
JIC x JIC M/F 45° ELBOW.....	J4MFS.....	D:5-20
UN 'O' RING x JIC 45° ELBOW.....	JU4M.....	D:5-20

www.hardyspicer.com.au

Document No:	HSYDCAT
Issue:	9
Issue Date:	01/04/12

ADAPTORS

DESCRIPTION	PART NO.	PAGE
90° ADAPTORS		
BSPT x BSPT 90° ELBOW.....	B9M.....	D:5-21
BSP x LP HOSE TAIL.....	BH9M.....	D:5-21
BSPP x JIC 90° ELBOW.....	JP9M.....	D:5-22
NPT x JIC 90° ELBOW.....	JN9M.....	D:5-23
JIC x JIC 90° ELBOW.....	J9M.....	D:5-23
BSPT x JIC 90° ELBOW.....	JB9M.....	D:5-24
JIC x JIC 90° BULKHEAD ELBOW.....	J90M.....	D:5-24
BSPT x BSPT M/F 90° ELBOW.....	B9MF.....	D:5-25
BSPT x BSPT F/F 90° ELBOW.....	B9F.....	D:5-25
UN 'O' RING x BSPT 90° ELBOW.....	BU9M.....	D:5-26
JIC x JIC M/F 90° ADAPTOR.....	J9MFS.....	D:5-26
UN 'O' RING x JIC 90° ELBOW.....	JU9M.....	D:5-27
BSPT x BSPP M/F 90° ELBOW.....	B9MFS.....	D:5-27
ORFS x ORFS 90° ELBOW.....	O9M.....	D:5-28
ORFS x UNO 'O' RING 90° ELBOW.....	OU9M.....	D:5-28
ORFS x ORFS M/F 90° ELBOW.....	O9MFS.....	D:5-28
TEES		
JIC x JIC x JIC M/M/M TEE.....	J5M.....	D:5-29
BSPT x BSPT x BSPT M/M/M TEE.....	B5M.....	D:5-29
BSPT x BSPT x BSPT F/F/F TEE.....	B5F.....	D:5-30
BSPT x BSPP x BSPT M/F/M TEE.....	B5FSM.....	D:5-30
JIC x BSPT x JIC M/M/M TEE.....	JB5M.....	D:5-31
JIC x NPT x JIC M/M/M TEE.....	JN5M.....	D:5-31
JIC x JIC x BSPT M/M/M TEE.....	BJ5M.....	D:5-32
JIC x JIC x JIC M/M/F TEE.....	J5MFS.....	D:5-32
UN 'O' RING x JIC x JIC M/M/M TEE.....	JU5M.....	D:5-33
JIC x JIC x UN 'O' RING M/M/M TEE.....	UJ5M.....	D:5-33
JIC x JIC x JIC M/F/M TEE.....	J5FSM.....	D:5-34
REDUCING BUSHES		
BSPT x BSPT REDUCING BUSH.....	B1R.....	D:5-34
NPT x NPT REDUCING BUSH.....	N1R.....	D:5-35
UN 'O' RING x UN 'O' RING REDUCING BUSH.....	U1R.....	D:5-35
BSPP x BSPP REDUCING BUSH.....	P1R.....	D:5-36
SOCKETS		
NPT x NPT SOCKET.....	N1F.....	D:5-36
BSPT x BSPT SOCKET.....	B1F.....	D:5-37
CAP NUT, PLUGS, TUBE NUTS & REDUCERS		
JIC CAP NUT.....	JCN.....	D:5-37
BSPT CAP NUT.....	BC.....	D:5-38
'O' RING FACE SEAL CAP NUT.....	OCN.....	D:5-38
LIGHT METRIC CAP.....	MCL.....	D:5-39
HEAVY METRIC CAP.....	MCH.....	D:5-39

Adaptors

www.hardyspicer.com.au

Document No:	HSHYDCAT
Issue:	9
Issue Date:	01/04/12

DESCRIPTION	PART NO.	PAGE
CAP NUT, PLUGS, TUBE NUTS & REDUCERS Cont.		
BSPP HEX PLUG.....	PP.....	D:5-40
BSPT PLUG.....	BP.....	D:5-40
NPT PLUG.....	NP.....	D:5-41
METRIC PLUG.....	MP.....	D:5-41
LIGHT METRIC PLUG.....	MPL.....	D:5-42
HEAVY METRIC PLUG.....	MPH.....	D:5-42
JIC PLUG.....	JP.....	D:5-43
UN 'O' RING PLUG.....	UP.....	D:5-43
'O' RING FACE SEAL PLUG.....	OP.....	D:5-44
JIC FLARE TUBE NUT & SLEEVE.....	JNS.....	D:5-44
JIC x JIC F/M TUBE REDUCER.....	JTR.....	D:5-45
TUBE ADAPTORS		
JIC x FLANGE HEAD STR. ADAPTOR.....	JF1M.....	D:5-45
JIC x FLANGE HEAD 45° ADAPTOR.....	JF4M.....	D:5-46
JIC x FLANGE HEAD 90° ADAPTOR.....	JF9M.....	D:5-46
JIC x JIC M/F 90° TUBE BEND.....	JST9MFS.....	D:5-47
JIC x JIC M/F 90° LONG TUBE BEND.....	JLT9MFS.....	D:5-47
FLANGES		
SAE SPLIT FLANGE - 3000 PSI.....	SFK.....	D:5-48
SAE SPLIT FLANGE - 6000 PSI.....	SFHK.....	D:5-48
TUBE WELD FITTINGS		
BSPT TUBE WELD NIPPLE.....	B25M.....	D:5-49
JIC TUBE WELD NIPPLE.....	J25M.....	D:5-49
3000 PSI TUBE WELD FLANGE.....	F25M.....	D:5-50
JIC FEMALE SWIVEL TUBE WELD.....	J25FS.....	D:5-50
6000 PSI TUBE WELD FLANGE.....	FH25M.....	D:5-51
FLARELESS FITTINGS		
FLARELESS FERRULE.....	FF.....	D:5-51
FLARELESS TUBE NUT.....	FN.....	D:5-51
SEALS		
'O' RING FOR SAE FLANGE.....	FOR.....	D:5-52
'O' RING FOR UN THREAD.....	UOR.....	D:5-52
METRIC BONDED SEALS.....	MSR.....	D:5-53
IMPERIAL BONDED SEALS.....	BS.....	D:5-53
PLASTIC CAPS & PLUGS		
BSP PLASTIC CAP.....	PBC.....	D:5-54
BSP PLACTIC PLUG.....	PBP.....	D:5-54
JIC PLASTIC CAP.....	PJC.....	D:5-54
JIC PLASTIC PLUG.....	PJP.....	D:5-54
CODE 61 PLASTIC FLANGE COVER.....	P3F.....	D:5-54
CODE 62 PLASTIC FLANGE COVER.....	P6F.....	D:5-54

www.hardyspicer.com.au

Document No:	HSHYDCAT
Issue:	9
Issue Date:	01/04/12

ADAPTORS

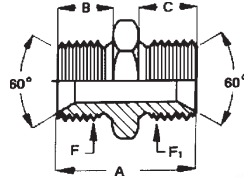

BSPP x BSPP NIPPLE

PART NO.	THRD F	THRD F1	DIMENSIONS mm		
			A	B	C
P1M-04-04	1/4" - 19	1/4" - 19	28	11	11
P1M-06-04	3/8" - 19	1/4" - 19	30	13	11
P1M-06-06	3/8" - 19	3/8" - 19	32	13	13
P1M-08-04	1/2" - 14	1/4" - 19	33	15	11
P1M-08-06	1/2" - 14	3/8" - 19	35	15	13
P1M-08-08	1/2" - 14	1/2" - 14	37	15	15
P1M-12-08	3/4" - 14	1/2" - 14	41	18	15
P1M-12-12	3/4" - 14	3/4" - 14	44	18	18
P1M-16-08	1" - 11	1/2" - 14	44	20	15
P1M-16-12	1" - 11	3/4" - 14	47	20	18
P1M-16-16	1" - 11	1" - 11	49	20	20
P1M-20-16	1-1/4" - 11	1" - 11	50	20	20
P1M-20-20	1-1/4" - 11	1-1/4"-11	50	20	20
P1M-24-20	1-1/2" - 11	1-1/4" - 11	54	21.5	20
P1M-24-24	1-1/2" - 11	1-1/2" - 11	55	21.5	21.5
P1M-32-24	2" - 11	1-1/2" - 11	59	25	21.5
P1M-32-32	2" - 11	2" - 11	63	25	25

BONDED SEALS INCLUDED

Adaptors

#INDENT ONLY

www.hardyspicer.com.au

Document No:	HSHYDCAT
Issue:	9
Issue Date:	01/04/12

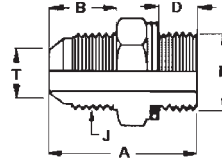

BSPP x JIC NIPPLE

PART NO.	THRD F BSPP	THRD J JIC	DIMENSIONS mm			TUBE SIZE	
			A	B	D	inch	
JP1M-02-07	1/8" - 28	7/16" - 20	27.0	14.0	8.0	1/4"	
JP1M-02-09	1/8" - 28	9/16" - 18	27.0	14.0	8.0	3/8"	
JP1M-04-07	1/4" - 19	7/16" - 20	34.5	14.0	10	1/4"	
JP1M-04-09	1/4" - 19	9/16" - 18	34.5	14.0	10	3/8"	
JP1M-04-12	1/4" - 19	3/4" - 16	34.5	17.0	10	1/2"	
JP1M-06-07	3/8" - 19	7/16" - 20	34.5	14.0	10	1/4"	
JP1M-06-09	3/8" - 19	9/16" - 18	34.5	14.0	10	3/8"	
JP1M-06-12	3/8" - 19	3/4" - 16	37.5	17.0	10	1/2"	
JP1M-06-14	3/8" - 19	7/8" - 14	40.5	19.5	10	5/8"	
JP1M-08-09	1/2" - 14	9/16" - 18	38.0	14.0	12	3/8"	
JP1M-08-12	1/2" - 14	3/4" - 16	41.0	17.0	12	1/2"	
JP1M-08-14	1/2" - 14	7/8" - 14	43.5	19.5	12	5/8"	
JP1M-08-17	1/2" - 14	1-1/16" - 12	47.0	22.0	12	3/4"	
JP1M-12-09	3/4" - 14	9/16" - 18	45.0	14	14	3/8"	
JP1M-12-12	3/4" - 14	3/4" - 16	45.0	17.0	14	1/2"	
JP1M-12-14	3/4" - 14	7/8" - 14	47.5	19.5	14	5/8"	
JP1M-12-17	3/4" - 14	1-1/16" - 12	50.0	22.0	14	3/4"	
JP1M-12-21	3/4" - 14	1-5/16" - 12	51.0	23.0	14	1"	
JP1M-16-17	1" - 11	1-1/16" - 12	52.5	22.0	15.5	3/4"	
JP1M-16-21	1" - 11	1-5/16" - 12	53.5	23.0	15.5	1"	
JP1M-16-26	1" - 11	1-5/8" - 12	55.5	24.5	15.5	1-1/4"	
JP1M-20-17	1-1/4" - 11	1-1/16" - 12	57.0	22.0	17.5	3/4"	
JP1M-20-21	1-1/4" - 11	1-5/16" - 12	57.0	23.0	17.5	1"	
JP1M-20-26	1-1/4" - 11	1-5/8" - 12	58.5	24.5	17.5	1-1/4"	
JP1M-20-30	1-1/4" - 11	1-7/8" - 12				1-1/2"	
JP1M-24-26	1-1/2" - 11	1-5/8" - 12				1-1/4"	
JP1M-24-30	1-1/2" - 11	1-7/8" - 12				1-1/2"	
JP1M-32-40	2" - 11	2-1/2" - 12				2"	

BONDED SEAL INCLUDED

www.hardyspicer.com.au

Document No:	HSHYDCAT
Issue:	9
Issue Date:	01/04/12

ADAPTORS

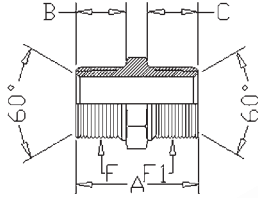

BSPT x BSPT NIPPLE

PART NO.	THRD F	THRD F1	DIMENSIONS mm		
			A	B	C
B1M-02-02	1/8" - 28	1/8" - 28	26	10	10
B1M-04-02	1/4" - 19	1/8" - 28	27	11	10
B1M-04-04	1/4" - 19	1/4" - 19	28	11	11
B1M-06-04	3/8" - 19	1/4" - 19	30	13	11
B1M-06-06	3/8" - 19	3/8" - 19	32	13	13
B1M-08-04	1/2" - 14	1/4" - 19	33	15	11
B1M-08-06	1/2" - 14	3/8" - 19	35	15	13
B1M-08-08	1/2" - 14	1/2" - 14	37	15	15
B1M-10-08	5/8" - 14	1/2" - 14			15
B1M-10-10	5/8" - 14	5/8" - 14			
B1M-12-04	3/4" - 14	1/4" - 19	37	18	11
B1M-12-06	3/4" - 14	3/8" - 19	39	18	13
B1M-12-08	3/4" - 14	1/2" - 14	41	18	15
B1M-12-12	3/4" - 14	3/4" - 14	44	18	18
B1M-16-08	1" - 11	1/2" - 14	44	20	15
B1M-16-12	1" - 11	3/4" - 14	47	20	18
B1M-16-16	1" - 11	1" - 11	49	20	20
B1M-20-12	1-1/4" - 11	3/4" - 14		20	18
B1M-20-16	1-1/4" - 11	1" - 11	50	20	20
B1M-20-20	1-1/4" - 11	1-1/4" - 11	50	20	20
B1M-24-16	1-1/2" - 11	1" - 11	54	21.5	20
B1M-24-20	1-1/2" - 11	1-1/4" - 11	54	21.5	20
B1M-24-24	1-1/2" - 11	1-1/2" - 11	55	21.5	21.5
B1M-32-24	2" - 11	1-1/2" - 11	59	25	21.5
B1M-32-32	2" - 11	2" - 11	63	25	25

Adaptors

www.hardyspicer.com.au

Document No:	HSHYDCAT
Issue:	9
Issue Date:	01/04/12

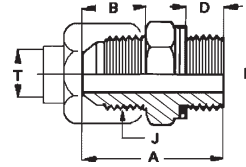

METRIC x JIC NIPPLE

PART NO.	THRD F METRIC	THRD J JIC	DIMENSIONS mm			TUBE SIZE	
			A	B	D	inch	
JM1M-06-07		7/16" - 20		14.0		1/4"	
JM1M-10-07		7/16" - 20		14.0		1/4"	
JM1M-12-07	12 x 1.5	7/16" - 20	33.0	14.0	10.0	1/4"	
JM1M-12-09	12 x 1.5	9/16" - 18	33.0	14.0	10.0	3/8"	
JM1M-12-12	12 x 1.5	3/4" - 16		17.0	10.0	1/2"	
JM1M-14-09	14 x 1.5	9/16" - 18	34.0	14.0	10.0	3/8"	
JM1M-14-12	14 x 1.5	3/4" - 16		17.0	10.0	1/2"	
JM1M-16-09	16 x 1.5	9/16" - 18	34.0	14.0	10.0	3/8"	
JM1M-16-12	16 x 1.5	3/4" - 16	37.0	17.0	10.0	1/2"	
JM1M-18-09	18 x 1.5	9/16" - 18	34.5	14.0	10.0	3/8"	
JM1M-18-12	18 x 1.5	3/4" - 16	37.5	17.0	10.0	1/2"	
JM1M-18-14	18 x 1.5	7/8" - 14			10.0	5/8"	
JM1M-18-17	18 x 1.5	1-1/16" - 12	42.5	22.0	10.0	3/4"	
JM1M-22-12	22 x 1.5	3/4" - 16		17.0	12.0	1/2"	
JM1M-22-14	22 x 1.5	7/8" - 14			12.0	5/8"	
JM1M-22-17	22 x 1.5	1-1/16" - 12	46.5	22.0	12.0	3/4"	
JM1M-22-21	22 x 1.5	1-5/16" - 12		23.0	12.0	1"	
JM1M-26-12	26 x 1.5	3/4" - 16	44.5	17.0	13.5	1/2"	
JM1M-26-17	26 x 1.5	1-1/16" - 12	49.0	22.0	12.0	3/4"	
JM1M-26-21	26 x 1.5	1-5/16" - 12	50.5	23.0	13.5	1"	
JM1M-27-21	27 x 2	1-5/16" - 12	50.5	23.0	13.5	1"	
JM1M-28-17	28 x 1.5	1-1/16" - 12		22.0		3/4"	
JM1M-33-17	33 x 2	1-1/16" - 12	53.5	23.0	15.5	3/4"	
JM1M-33-21	33 x 2	1-5/16" - 12	53.5	23.0	15.5	1"	
JM1M-33-26	33 x 2	1-5/8" - 12		24.5	15.5	1-1/4"	
JM1M-42-21	42 x 2	1-5/16" - 12		23.0	17.5	1"	
JM1M-42-26	42 x 2	1-5/8" - 12	58.5	24.5	17.5	1-1/4"	
JM1M-42-30	42 x 2	1-7/8" - 12	65.5	27.5	17.5	1-1/2"	
JM1M-48-30	48 x 2	1-7/8" - 12	65.5	27.5	19.5	1-1/2"	
#JM1M-48-40	48 x 2	2-1/2" - 12	67.5	30.0	19.5	2"	

METRIC SEALS SOLD SEPARATELY MSR-

www.hardyspicer.com.au

Document No:	HSYDCAT
Issue:	9
Issue Date:	01/04/12

INDENT ONLY

ADAPTORS

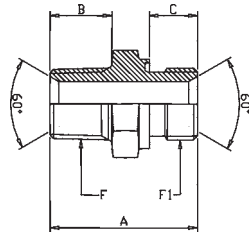

BSPT x BSPP NIPPLE

PART NO.	THRD F BSPT	THRD F1 BSPP	DIMENSIONS mm		
			A	B	C
BP1M-04-04	1/4" - 19	1/4" - 19	28	11	11
BP1M-04-06	1/4" - 19	3/8" - 19			
BP1M-06-04	3/8" - 19	1/4" - 19			
BP1M-06-06	3/8" - 19	3/8" - 19	32	13	13
BP1M-06-08	3/8" - 19	1/2" - 14			
BP1M-08-06	1/2" - 14	3/8" - 19			
BP1M-08-08	1/2" - 14	1/2" - 14	37	15	15
BP1M-08-12	1/2" - 14	3/4" - 14			
BP1M-12-08	3/4" - 14	1/2" - 14			
BP1M-12-12	3/4" - 14	3/4" - 14	44	18	18
BP1M-12-16	3/4" - 14	1" - 11			
BP1M-16-12	1" - 11	3/4" - 14			
BP1M-16-16	1" - 11	1" - 11	49	20	20
BP1M-16-20	1" - 11	1-1/4" - 11			
BP1M-20-16	1-1/4" - 11	1" - 11			
BP1M-20-20	1-1/4" - 11	1-1/4" - 11	50	20	20
BP1M-24-24	1-1/2" - 11	1-1/2" - 11			

BONDED SEAL INCLUDED

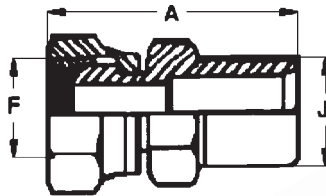

BSPP x BSPT M/F UNION

PART NO.	THRD F FEMALE BSPP	THRD J MALE BSPT	DIMENSIONS mm		
			A		
B1MFS-02-02	1/8" - 28	1/8" - 28	28		
B1MFS-04-04	1/4" - 19	1/4" - 19	32		
B1MFS-06-06	3/8" - 19	3/8" - 19	34		
B1MFS-06-08	3/8" - 19	1/2" - 14	36		
B1MFS-08-06	1/2" - 14	3/8" - 14			
B1MFS-08-08	1/2" - 14	1/2" - 14	42		
B1MFS-12-08	3/4" - 14	1/2" - 14			
B1MFS-12-12	3/4" - 14	3/4" - 14	43		
B1MFS-12-16	3/4" - 14	1" - 11			
B1MFS-16-12	1" - 11	3/4" - 14			
B1MFS-16-16	1" - 11	1" - 11	57		
B1MFS-20-20	1-1/4" - 11	1-1/4" - 11			
#B1MFS-24-24	1-1/2" - 11	1-1/2" - 11			

INDENT ONLY

Adaptors

www.hardyspicer.com.au

Document No:	HSHYDCAT
Issue:	9
Issue Date:	01/04/12

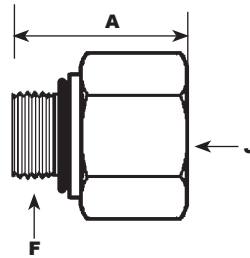

UN O-RING x BSPT M/F ADAPTOR

PART NO.	THRD F UNO MALE	THRD J BSPT FEMALE	DIMENSIONS mm							
			A							
#UB1MF-09-04	9/16" - 18	1/4" - 19								
UB1MF-12-06	3/4" - 16	3/8" - 19								
UB1MF-12-08	3/4" - 16	1/2" - 14	47.6							
#UB1MF-14-06	7/8" - 14	3/8" - 19								
UB1MF-14-08	7/8" - 14	1/2" - 14	47.6							
UB1MF-17-12	1-1/16" - 12	3/4" - 14	49.0							
UB1MF-21-16	1-5/16" - 12	1" - 11								

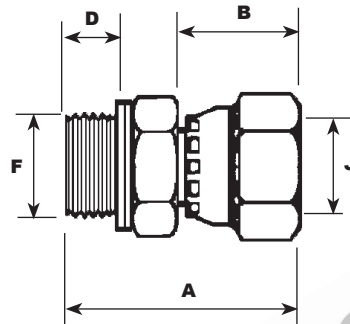

BSPP x JIC M/F ADAPTOR

PART NO.	THRD F BSPP MALE	THRD J JIC FEMALE	DIMENSIONS mm			TUBE SIZE	
			A	B	D	inch	
PJ1MFS-02-07	1/8" - 28	7/16" - 20					1/4"
PJ1MFS-04-07	1/4" - 19	7/16" - 20					1/4"
PJ1MFS-04-09	1/4" - 19	9/16" - 18	42.0	21.5	10.0		3/8"
PJ1MFS-06-09	3/8" - 19	9/16" - 18	43.5	23.0	10.0		3/8"
PJ1MFS-06-12	3/8" - 19	3/4" - 16	43.5	23.0	10.0		1/2"
PJ1MFS-08-12	1/2" - 14	3/4" - 16	47.0	23.0	12.0		1/2"
PJ1MFS-08-14	1/2" - 14	7/8" - 14	50.0	26.0	12.0		5/8"
PJ1MFS-12-17	3/4" - 14	1-1/16"-12	55.5	27.5	14.0		3/4"
PJ1MFS-16-21	1" - 11	1-5/16"-12	60.5	30.0	15.5		1"

BONDED SEAL INCLUDED

www.hardyspicer.com.au

Document No:	HSYDCAT
Issue:	9
Issue Date:	01/04/12

INDENT ONLY

ADAPTORS

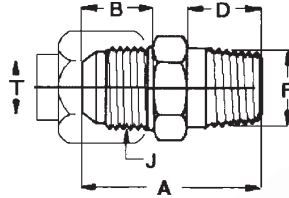

NPT x JIC NIPPLE

PART NO.	THRD F NPT	THRD J JIC	DIMENSIONS mm			TUBE SIZE	
			A	B	D	inch	
JN1M-02-07	1/8" - 27	7/16" - 20	31.0	14.0	10.0	1/4"	
JN1M-02-08	1/8" - 27	1/2" - 20			10.0	5/16"	
JN1M-02-09	1/8" - 27	9/16" - 18		14.0	10.0	3/8"	
JN1M-04-07	1/4" - 18	7/16" - 20	35.5	14.0	14.5	1/4"	
JN1M-04-08	1/4" - 18	1/2" - 20				5/16"	
JN1M-04-09	1/4" - 18	9/16" - 18	36.0	14.0	14.5	3/8"	
JN1M-04-12	1/4" - 18	3/4" - 16	39.0	17.0	14.5	1/2"	
JN1M-06-07	3/8" - 18	7/16" - 20		14.0	14.5	1/4"	
JN1M-06-08	3/8" - 18	1/2" - 20			14.5	5/16"	
JN1M-06-09	3/8" - 18	9/16" - 18	36.0	14.0	14.5	3/8"	
JN1M-06-12	3/8" - 18	3/4" - 16	39.0	17.0	14.5	1/2"	
JN1M-06-14	3/8" - 18	7/8" - 14		19.5	14.5	5/8"	
JN1M-08-09	1/2" - 14	9/16" - 18		14.0	19.0	3/8"	
JN1M-08-12	1/2" - 14	3/4" - 16	45.5	17.0	19.0	1/2"	
JN1M-08-14	1/2" - 14	7/8" - 14	48.0	19.5	19.0	5/8"	
JN1M-08-17	1/2" - 14	1-1/16"-12	52.5	22.0	19.0	3/4"	
JN1M-12-09	3/4" - 14	9/16" - 18		14.0	19.0	3/8"	
JN1M-12-12	3/4" - 14	3/4" - 16	47.5	17.0	19.0	1/2"	
JN1M-12-14	3/4" - 14	7/8" - 14	50.0	19.5	19.0	5/8"	
JN1M-12-17	3/4" - 14	1-1/16"-12	52.5	22.0	19.0	3/4"	
JN1M-12-21	3/4" - 14	1-5/16"-12				1"	
JN1M-16-17	1"-11 1/2	1-1/16"-12	51.5	22.0	19.0	3/4"	
JN1M-16-21	1"-11 1/2	1-5/16"-12	58.5	23.0	24.0	1"	
JN1M-16-26	1"-11 1/2	1-5/8"-12				1-1/4"	
JN1M-20-21	1-1/4"-11 1/2	1-5/16"-12				1"	
JN1M-20-26	1-1/4"-11 1/2	1-5/8"-12	62.0	24.5	24.5	1-1/4"	
JN1M-24-26	1-1/2"-11 1/2	1-5/8"-12				1-1/4"	
JN1M-24-30	1-1/2"-11 1/2	1-7/8"-12				1-1/2"	
JN1M-32-40	2" - 11 1/2	2-1/2"-12				2"	

Adaptors

INDENT ONLY

www.hardyspicer.com.au

Document No:	HSHYDCAT
Issue:	9
Issue Date:	01/04/12

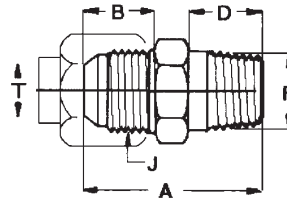

BSPT x JIC NIPPLE

PART NO.	THRD F BSPT	THRD J JIC	DIMENSIONS mm			TUBE SIZE	
			A	B	D	inch	
JB1M-02-07	1/8" - 28	7/16" - 20	29.0	14.0	8	1/4"	
JB1M-02-08	1/8" - 28	1/2" - 20				5/16"	
JB1M-02-09	1/8" - 28	9/16" - 18	33.0	14.0	8	3/8"	
JB1M-04-07	1/4" - 19	7/16" - 20	33.0	14.0	12	1/4"	
JB1M-04-08	1/4" - 19	1/2" - 20				5/16"	
JB1M-04-09	1/4" - 19	9/16" - 18	33.5	14.0	12	3/8"	
JB1M-04-12	1/4" - 19	3/4" - 16	36.5	17.0	12	1/2"	
JB1M-06-07	3/8" - 19	7/16" - 20				1/4"	
JB1M-06-08	3/8" - 19	1/2" - 20				5/16"	
JB1M-06-09	3/8" - 19	9/16" - 18	33.5	14.0	12	3/8"	
JB1M-06-12	3/8" - 19	3/4" - 16	36.5	17.0	12	1/2"	
JB1M-06-14	3/8" - 19	7/8" - 14	41.0	19.5	12	5/8"	
JB1M-06-17	3/8" - 19	1-1/16"-12				3/4"	
JB1M-08-07	1/2" - 14	7/16" - 20				1/4"	
JB1M-08-09	1/2" - 14	9/16" - 18	37.5	14.0	14	3/8"	
JB1M-08-12	1/2" - 14	3/4" - 16	40.5	17.0	14	5/8"	
JB1M-08-14	1/2" - 14	7/8" - 14	43.0	19.5	14	5/8"	
JB1M-08-17	1/2" - 14	1-1/16"-12	47.5	22.0	14	3/4"	
JB1M-12-09	3/4" - 14	9/16" - 18				3/8"	
JB1M-12-12	3/4" - 14	3/4" - 16	42.5	17.0	16	1/2"	
JB1M-12-14	3/4" - 14	7/8" - 14	47.0	19.5	16	5/8"	
JB1M-12-17	3/4" - 14	1-1/16"-12	49.5	22.0	16	3/4"	
#JB1M-12-19	3/4" - 14	1-3/16"-12				7/8"	
JB1M-12-21	3/4" - 14	1-5/16"-12	50.5	23.0	16	1"	
JB1M-16-12	1" - 11	3/4" - 14				1/2"	
#JB1M-16-14	1" - 11	7/8" - 14				5/8"	
JB1M-16-17	1" - 11	1-1/16"-12	51.5	22.0	18	3/4"	
JB1M-16-21	1" - 11	1-5/16"-12	52.5	23.0	18	1"	
JB1M-16-26	1" - 11	1-5/8" - 12	55.5	24.5	18	1-1/4"	
JB1M-20-17	1-1/4" - 11	1-1/16"-12				3/4"	
JB1M-20-21	1-1/4" - 11	1-5/16"-12	56.0	24.5	20	1"	
JB1M-20-26	1-1/4" - 11	1-5/8" - 12	57.5	24.5	20	1-1/4"	
JB1M-20-30	1-1/4" - 11	1-7/8" - 12				1-1/2"	
JB1M-24-21	1-1/2" - 11	1-5/16"-12				1"	
JB1M-24-26	1-1/2" - 11	1-5/8" - 12	57.5	24.5	20	1-1/4"	
JB1M-24-30	1-1/2" - 11	1-7/8" - 12	62.5	27.5	29	1-1/2"	
JB1M-32-40	2" - 11	2-1/2" - 12				2"	

www.hardyspicer.com.au

Document No:	HSHYDCAT
Issue:	9
Issue Date:	01/04/12

INDENT ONLY

ADAPTORS

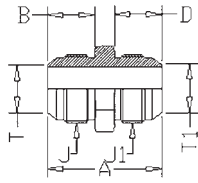

JIC x JIC NIPPLE

PART NO.	THRD J	THRD J	DIMENSIONS mm		TUBE SIZE	
			A	B	inch	inch
J1M-07-07	7/16" - 20	7/16" - 20	34.5	14.0	1/4"	1/4"
J1M-08-08	1/2" - 20	1/2" - 20			5/16"	5/16"
J1M-09-07	9/16" - 18	7/16" - 20			3/8"	1/4"
J1M-09-09	9/16" - 18	9/16" - 18	35.5	14.0	3/8"	3/8"
J1M-12-09	3/4" - 16	9/16" - 18			1/2"	3/8"
J1M-12-12	3/4" - 16	3/4" - 16	41.0	17.0	1/2"	1/2"
J1M-14-09	7/8" - 14	9/16" - 18			5/8"	3/8"
J1M-14-12	7/8" - 14	3/4" - 16			5/8"	1/2"
J1M-14-14	7/8" - 14	7/8" - 14	47.5	19.5	5/8"	5/8"
J1M-17-12	1-1/16"-12	3/4" - 16			3/4"	1/2"
J1M-17-14	1-1/16"-12	7/8" - 14			3/4"	5/8"
J1M-17-17	1-1/16"-12	1-1/16"-12	55.0	22.0	3/4"	3/4"
J1M-21-14	1-5/16"-12	7/8" - 14			1"	5/8"
J1M-21-17	1-5/16"-12	1-1/16"-12			1"	3/4"
J1M-21-21	1-5/16"-12	1-5/16"-12	57.0	23.0	1"	1"
J1M-26-21	1-5/8" - 12	1-5/16"-12			1-1/4"	1"
J1M-26-26	1-5/8" - 12	1-5/8" - 12	61.5	24.5	1-1/4"	1-1/4"
J1M-30-30	1-7/8" - 12	1-7/8" - 12	69.5	27.5	1-1/2"	1-1/2"
J1M-40-40	2-1/2" - 12	2-1/2" - 12			2"	2"

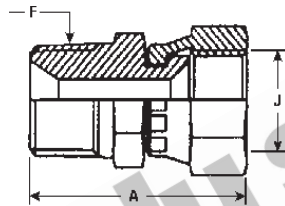

BSPT x JIC M/F UNION

PART NO.	THRD F	THRD J	DIMENSIONS mm		TUBE SIZE	
	MALE BSPT	FEMALE JIC	A		inch	
BJ1MF-02-07	1/8" - 28	7/16" - 20			1/4"	
BJ1MF-04-07	1/4" - 19	7/16" - 20			1/4"	
BJ1MF-04-09	1/4" - 19	9/16" - 18	41.0		3/8"	
BJ1MF-06-09	3/8" - 19	9/16" - 18	41.0		3/8"	
BJ1MF-06-12	3/8" - 19	3/4" - 16			1/2"	
BJ1MF-08-12	1/2" - 14	3/4" - 16	46.5		1/2"	
BJ1MF-08-14	1/2" - 14	7/8" - 14	49.5		5/8"	
BJ1MF-12-17	3/4" - 14	1-1/16"-12	53.0		3/4"	
BJ1MF-16-21	1" - 11	1-5/16"-12	59.5		1"	

Adaptors

#INDENT ONLY

www.hardyspicer.com.au	
Document No:	HSHYDCAT
Issue:	9
Issue Date:	01/04/12

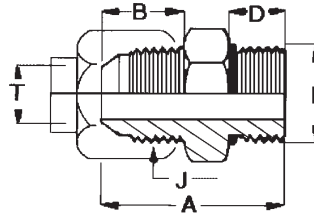

UN 'O' RING x JIC NIPPLE

PART NO.	THRD F UNO	THRD J JIC	DIMENSIONS mm			TUBE SIZE	
			A	B	D	inch	
JU1M-07-07	7/16" - 20	7/16" - 20	31.0	14.0	9.5	1/4"	
JU1M-07-09	7/16" - 20	9/16" - 18	33.0	14.0	10.0	3/8"	
JU1M-08-08	1/2" - 20	1/2" - 20				5/16"	
JU1M-08-09	1/2" - 20	9/16" - 18	31.0	14.0	9.5	3/8"	
JU1M-09-07	9/16" - 18	7/16" - 20	33.0	14.0	10.0	1/4"	
JU1M-09-08	9/16" - 18	1/2" - 20				5/16"	
JU1M-09-09	9/16" - 18	9/16" - 18	33.0	14.0	10.0	3/8"	
JU1M-09-12	9/16" - 18	3/4" - 16	34.5	14.0	11.5	1/2"	
JU1M-09-14	9/16" - 18	7/8" - 14				5/8"	
JU1M-12-07	3/4" - 16	7/16" - 20				1/4"	
JU1M-12-09	3/4" - 16	9/16" - 18	34.5	14.0	11.5	3/8"	
JU1M-12-12	3/4" - 16	3/4" - 16	37.5	17.0	11.5	1/2"	
JU1M-12-14	3/4" - 16	7/8" - 14	40.5	19.5	11.5	5/8"	
JU1M-12-17	3/4" - 16	1-1/16"-12	45.0	22.0	11.5	3/4"	
JU1M-14-09	7/8" - 14	9/16" - 18	40.0	17.0	13.0	3/8"	
JU1M-14-12	7/8" - 14	3/4" - 16	40.5	17.0	13.0	1/2"	
JU1M-14-14	7/8" - 14	7/8" - 14	43.0	19.5	13.0	5/8"	
JU1M-14-17	7/8" - 14	1-1/16"-12	46.5	22.0	13.0	3/4"	
JU1M-14-21	7/8" - 14	1-5/16"-12				1"	
JU1M-17-09	1-1/16"-12	9/16" - 18				3/8"	
JU1M-17-12	1-1/16"-12	3/4" - 16	45.0	17.0	15.5	1/2"	
JU1M-17-14	1-1/16"-12	7/8" - 14	46.5	22.0	13.0	5/8"	
JU1M-17-17	1-1/16"-12	1-1/16"-12	50.0	22.0	15.5	3/4"	
JU1M-17-21	1-1/16"-12	1-5/16"-12	51.0	23.0	15.5	1"	
JU1M-17-26	1-1/16"-12	1-5/8" - 12				1-1/4"	
JU1M-21-12	1-5/16"-12	3/4" - 16				1/2"	
JU1M-21-14	1-5/16"-12	7/8" - 14				5/8"	
JU1M-21-17	1-5/16"-12	1-1/16"-12	51.0	22.0	15.5	3/4"	
JU1M-21-21	1-5/16"-12	1-5/16"-12	52.0	23.0	15.5	1"	
JU1M-21-26	1-5/16"-12	1-5/8" - 12	52.0	23.0	15.5	1-1/4"	
JU1M-26-17	1-5/8" - 12	1-1/16"-12				3/4"	
JU1M-26-21	1-5/8" - 12	1-5/16"-12	52.0	23.0	15.5	1"	
JU1M-26-26	1-5/8" - 12	1-5/8" - 12	55.0	24.5	15.5	1-1/4"	
JU1M-26-30	1-5/8" - 12	1-7/8" - 12	60.0	27.5	15.5	1-1/2"	
JU1M-30-26	1-7/8" - 12	1-5/8" - 12	60.0	27.5	15.5	1-1/4"	
JU1M-30-30	1-7/8" - 12	1-7/8" - 12	60.0	27.5	15.5	1-1/2"	

www.hardyspicer.com.au

Document No:	HSYDCAT
Issue:	9
Issue Date:	01/04/12

INDENT ONLY

ADAPTORS

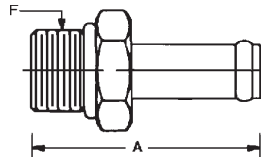

UN 'O' RING x LP HOSE TAIL

PART NO.	THRD F	HOSE SIZE	DIMENSIONS mm			
			A			
#UH1M-14-12	7/8" - 14	3/4"				
#UH1M-14-16	7/8" - 14	1"				
#UH1M-17-12	1-1/16"-12	3/4"				
UH1M-17-16	1-1/16"-12	1"	62.7			
UH1M-17-20	1-1/16"-12	1-1/4"				
UH1M-21-16	1-5/16"-12	1"	62.7			
UH1M-21-20	1-5/16"-12	1-1/4"	62.7			
UH1M-21-24	1-5/16"-12	1-1/2"				
UH1M-26-20	1-5/8" - 12	1-1/4"	62.7			
UH1M-26-24	1-5/8" - 12	1-1/2"	62.7			

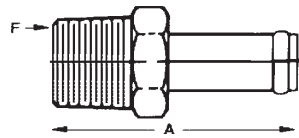

BSPT x LP HOSE TAIL

PART NO.	THRD F	HOSE SIZE	DIMENSIONS mm			
			A			
BH1M-08-12	1/2" - 12	3/4"				
BH1M-12-12	3/4" - 14	3/4"	65			
BH1M-12-16	3/4" - 14	1"	72			
BH1M-12-20	3/4" - 14	1-1/4"	68			
BH1M-16-12	1" - 11	3/4"				
BH1M-16-16	1" - 11	1"	67			
BH1M-16-20	1" - 11	1-1/4"	73			
BH1M-16-24	1" - 11	1-1/2"	72			
BH1M-20-16	1-1/4" - 11	1"	74			
BH1M-20-20	1-1/4" - 11	1-1/4"	75			
BH1M-20-24	1-1/4" - 11	1-1/2"	75			
BH1M-24-20	1-1/2" - 11	1-1/4"	75			
BH1M-24-24	1-1/2" - 11	1-1/2"	78			
BH1M-32-32	2" - 11	2"	95			

INDENT ONLY

www.hardyspicer.com.au

Document No:	HSHYDCAT
Issue:	9
Issue Date:	01/04/12

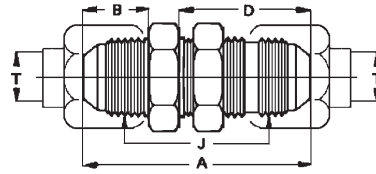

JIC x JIC BULKHEAD NIPPLE

PART NO.	THRD J	DIMENSIONS mm			TUBE SIZE	
		A	B	D	inch	
J10M-07-07	7/16" - 20	52.5	14.0	31.5	1/4"	
J10M-08-08	1/2" - 20				5/16"	
J10M-09-09	9/16"-18	55.5	14.0	35.5	3/8"	
J10M-12-12	3/4" - 16	62.0	17.0	37.5	1/2"	
J10M-14-14	7/8" - 14	69.5	19.5	41.0	5/8"	
J10M-17-17	1-1/16"-12	78.5	22.0	45.5	3/4"	
J10M-21-21	1-5/16"-12	80.0	23.0	45.5	1"	
J10M-26-26	1-5/8" - 12				1-1/4"	
J10M-30-30	1-7/8" - 12				1-1/2"	

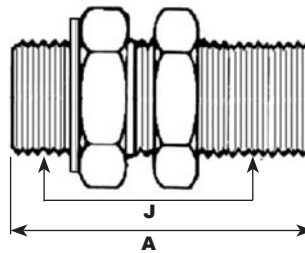

BSPP BULKHEAD NIPPLE

PART NO.	THRD J	DIMENSIONS mm			TUBE SIZE	
		A	B	D	inch	
B10M-04-04	1/4" - 19	47.0				
B10M-06-06	3/8" - 19	50.0				
B10M-08-08	1/2" - 14	59.0				
B10M-12-12	3/4" - 14	61.0				
B10M-16-16	1" - 11	74.0				
B10M-20-20	1-1/4"-11	71.0				
B10M-24-24	1-1/2"-11	86.0				

BONDED SEAL INCLUDED

www.hardyspicer.com.au

Document No:	HSYDCAT
Issue:	9
Issue Date:	01/04/12

Adaptors

ADAPTORS

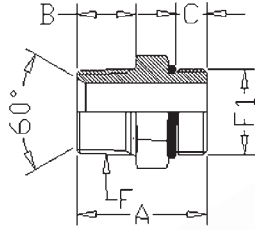

UN 'O' RING x BSPT NIPPLE

PART NO.	THRD F1 UNO	THRD F BSPT	DIMENSIONS mm		
			A	B	C
BU1M-07-04	7/16" - 20	1/4" - 19	28.6	13	9.1
BU1M-09-04	9/16" - 18	1/4" - 19	30.0	11	10.0
BU1M-09-06	9/16" - 18	3/8" - 19			
BU1M-09-08	9/16" - 18	1/2" - 14			
BU1M-12-04	3/4" - 16	1/4" - 19			
BU1M-12-06	3/4" - 16	3/8" - 19	33.5	13	11.5
BU1M-12-08	3/4" - 16	1/2" - 14	36.0	15	11.5
BU1M-12-12	3/4" - 16	3/4" - 14			
BU1M-14-04	7/8" - 14	1/4" - 19			
BU1M-14-06	7/8" - 14	3/8" - 19			
BU1M-14-08	7/8" - 14	1/2" - 14	38.5	15	13.0
BU1M-14-12	7/8" - 14	3/4" - 14	42.2	18	13.0
BU1M-17-08	1-1/16"-12	1/2" - 14	43.0	15	15.5
BU1M-17-12	1-1/16"-12	3/4" - 14	46.0	18	15.5
BU1M-17-16	1-1/16"-12	1" - 11	48.0	20	15.5
BU1M-21-12	1-5/16"-12	3/4" - 14	47.0	18	15.5
BU1M-21-16	1-5/16"-12	1" - 11	49.0	20	15.5
BU1M-21-20	1-5/16"-12	1-1/4" - 11	50.5	20	15.5
BU1M-26-16	1-5/8" - 12	1" - 11			
BU1M-26-20	1-5/8" - 12	1-1/4" - 11	50.5	20	15.5
BU1M-26-24	1-5/8" - 12	1-1/2" - 11			

Adaptors

www.hardyspicer.com.au

Document No:	HSHYDCAT
Issue:	9
Issue Date:	01/04/12

Adaptors

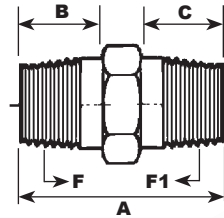

NPT x NPT NIPPLE

PART NO.	THRD F	THRD F1	DIMENSIONS mm					
			A	B	C			
N1M-02-02	1/8" - 28	1/8" - 28	27	10	10			
N1M-04-02	1/4" - 18	1/8" - 28						
N1M-04-04	1/4" - 18	1/4" - 18	28	11	11			
N1M-06-04	3/8" - 18	1/4" - 18						
N1M-06-06	3/8" - 18	3/8" - 18	32	13	13			
N1M-08-06	1/2" - 14	3/8" - 18						
N1M-08-08	1/2" - 14	1/2" - 14	37	15	15			
N1M-12-12	3/4" - 14	3/4" - 14	44	18	18			
N1M-16-12	1" - 11 1/2	3/4" - 14						
N1M-16-16	1" - 11 1/2	1" - 11 1/2	49	20	20			
N1M-20-16	1-1/4" - 11 1/2	1" - 11 1/2						
N1M-20-20	1-1/4" - 11 1/2	1-1/4" - 11 1/2						
N1M-24-24	1-1/2" - 11 1/2	1-1/2" - 11 1/2						
N1M-32-32	2" - 11 1/2	2" - 11 1/2						

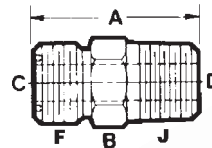

'O' RING FACE SEAL x BSPT NIPPLE

PART NO.	THRD F ORFS	THRD J BSPT	DIMENSIONS mm				TUBE O.D.	
			A	B	C	D		
OB1M-04-09	9/16" - 18	1/4" - 19	31.2	16.0	4.3	7.1	1/4"	
OB1M-04-11	11/16" - 16	1/4" - 19					3/8"	
OB1M-06-11	11/16" - 16	3/8" - 19	33.0	19.0	6.8	9.6	3/8"	
OB1M-06-13	13/16" - 16	3/8" - 19					1/2"	
OB1M-08-13	13/16" - 16	1/2" - 14	40.9	22.3	9.6	9.6	1/2"	
OB1M-08-19	1-3/16" - 12	1/2" - 14					3/4"	
OB1M-12-19	1-3/16" - 12	3/4" - 14	46.7	33.3	15.5	17.5	3/4"	
OB1M-12-23	1-7/16" - 12	3/4" - 14					1"	
OB1M-16-23	1-7/16" - 12	1" - 11	52.1	39.6	20.6	22.3	1"	

www.hardyspicer.com.au

Document No:	HSYDCAT
Issue:	9
Issue Date:	01/04/12

INDENT ONLY

ADAPTORS

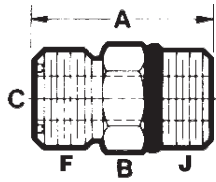

'O' RING FACE SEAL x UNO 'O' RING

PART NO.	THRD F ORFS	THRD J UNO	DIMENSIONS mm			TUBE O.D.
			A	B	C	
OU1M-07-09	9/16" - 18	7/16" - 20	28.7	16.0	4.3	1/4"
OU1M-09-09	9/16" - 18	9/16" - 18				
OU1M-09-11	11/16" - 16	9/16" - 18	31.7	19.0	6.8	3/8"
OU1M-12-13	13/16" - 16	3/4" - 16	36.6	22.3	9.6	1/2"
OU1M-17-19	1-3/16" - 12	1-1/16" - 12	48.5	31.7	15.5	3/4"
OU1M-21-23	1-7/16" - 12	1-5/16" - 12	50.3	38.1	20.6	1"

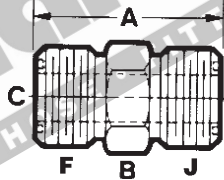

'O' RING FACE SEAL x 'O' RING FACE SEAL

PART NO.	THRD F	THRD J	DIMENSIONS mm			TUBE O.D.
			A	B	C	
O1M-09-09	9/16" - 18	9/16" - 18	27.4	16.0	4.3	1/4"
O1M-11-11	11/16" - 16	11/16" - 16	31.0	19.0	6.8	3/8"
O1M-13-13	13/16" - 16	13/16" - 16	35.3	22.3	9.6	1/2"
O1M-16-13	1" - 14	13/16" - 16				5/8"-1/2"
O1M-16-16	1" - 14	1" - 14				5/8"
O1M-19-19	1-3/16" - 12	1-3/16" - 12	47.2	31.7	15.5	3/4"
O1M-23-23	1-7/16" - 12	1-7/16" - 12	49.3	38.1	20.6	1"

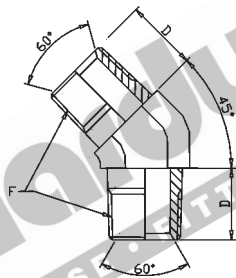

BSPT x BSPT 45° ELBOW

PART NO.	THRD F	DIMENSIONS mm		
		D		
B4M-02-02	1/8" - 28			
B4M-04-04	1/4" - 19	21.0		
B4M-06-06	3/8" - 19	25.0		
B4M-08-08	1/2" - 14	28.0		
B4M-12-12	3/4" - 14	32.5		
B4M-16-16	1" - 11	37.0		

#INDENT ONLY°

www.hardyspicer.com.au

Document No:	HSHYDCAT
Issue:	9
Issue Date:	01/04/12

Adaptors

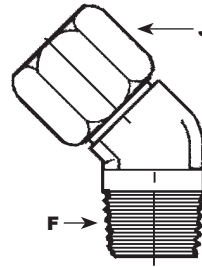

BSPT x BSPP M/F SWIVEL 45° ELBOW

PART NO.	THRD F MALE BSPT	THRD J FEMALE BSPP	DIMENSIONS mm			TUBE SIZE	
			B	C	inch		
B4MFS-04-04	1/4" - 19	1/4" - 19					
B4MFS-06-06	3/8" - 19	3/8" - 19					
B4MFS-08-08	1/2" - 14	1/2" - 14					
B4MFS-12-12	3/4" - 14	3/4" - 14					
B4MFS-16-16	1" - 16	1" - 16					

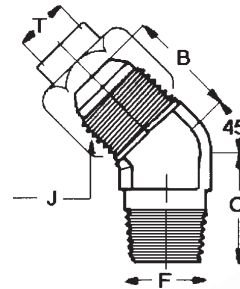

BSPT x JIC 45° ELBOW

PART NO.	THRD F BSPT	THRD J JIC	DIMENSIONS mm			TUBE SIZE	
			B	C	inch		
JB4M-02-07	1/8" - 28	7/16" - 20	18.0	16.0	1/4"		
JB4M-04-07	1/4" - 18	7/16" - 20			1/4"		
#JB4M-04-08	1/4" - 18	1/2" - 20			5/16"		
JB4M-04-09	1/4" - 18	9/16" - 18	21.0	21.5	3/8"		
JB4M-06-09	3/8" - 18	9/16" - 18			3/8"		
JB4M-06-12	3/8" - 18	3/4" - 16	25.0	24.0	1/2"		
JB4M-08-12	1/2" - 14	3/4" - 16	25.5	29.5	1/2"		
JB4M-08-14	1/2" - 14	7/8" - 14	28.0	29.5	5/8"		
#JB4M-08-17	1/2" - 14	1-1/16"-12	32.5	30.5	3/4"		
JB4M-12-14	3/4" - 14	7/8" - 14			5/8"		
JB4M-12-17	3/4" - 14	1-1/16"-12	32.5	30.5	3/4"		
JB4M-16-21	1" - 11	1-5/16"-12	37.0	37.5	1"		
JB4M-20-26	1-1/4"-11	1-5/8" - 12	40.5	42.5	1-1/4"		

www.hardyspicer.com.au

Document No:	HSYDCAT
Issue:	9
Issue Date:	01/04/12

INDENT ONLY

ADAPTORS

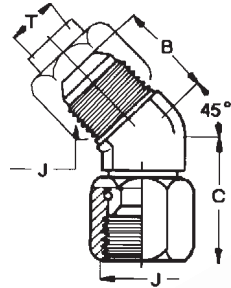

JIC x JIC M/F 45° ELBOW

PART NO.	THRD J	DIMENSIONS mm		TUBE SIZE	
		B	C	inch	
J4MFS-07-07	7/16"-20	18.0	24.5	1/4"	
J4MFS-09-09	9/16"-18	21.0	28.5	3/8"	
J4MFS-12-12	3/4"-16	25.0	32.0	1/2"	
J4MFS-14-14	7/8"-14	28.0	37.0	5/8"	
J4MFS-17-17	1-1/16"-12	32.5	38.5	3/4"	
J4MFS-21-21	1-5/16"-12	37.0	45.0	1"	
J4MFS-26-26	1-5/8"-12	40.5	51.5	1-1/4"	
J4MFS-30-30	1-7/8"-12	57.0	60.0	1-1/2"	

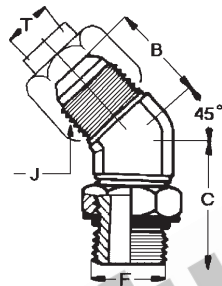

UN 'O' RING x JIC 45° ELBOW

PART NO.	THRD F UNO	THRD J JIC	DIMENSIONS mm		TUBE SIZE	
			B	C	inch	
JU4M-07-07	7/16"-20	7/16"-20			1/4"	
JU4M-09-09	9/16"-18	9/16"-18	21.0	29.0	3/8"	
JU4M-12-09	3/4"-16	9/16"-18	22.0	33.0	3/8"	
JU4M-12-12	3/4"-16	3/4"-16	25.0	33.0	1/2"	
JU4M-12-14	3/4"-16	7/8"-14	28.0	35.0	5/8"	
JU4M-14-12	7/8"-14	3/4"-16	25.5	38.5	1/2"	
JU4M-14-14	7/8"-14	7/8"-14	28.0	38.5	5/8"	
JU4M-14-17	7/8"-14	1-1/16"-12	32.5	40.5	3/4"	
JU4M-17-14	1-1/16"-12	7/8"-14	30.0	44.0	5/8"	
JU4M-17-17	1-1/16"-12	1-1/16"-12	32.5	44.0	3/4"	
JU4M-21-21	1-5/16"-12	1-5/16"-12	37.0	47.0	1"	

Adaptors

www.hardyspicer.com.au

Document No:	HSYDCAT
Issue:	9
Issue Date:	01/04/12

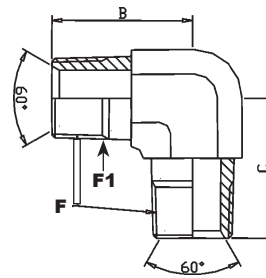

BSPT x BSPT 90° ELBOW

PART NO.	THRD F	THRD F1	DIMENSIONS mm					
			B	C				
B9M-02-02	1/8"-28	1/8"-28	25	25				
B9M-04-02	1/4"-19	1/8"-28	27	25				
B9M-04-04	1/4"-19	1/4"-19	27	22				
B9M-06-04	3/8"-19	1/4"-19	30	28				
B9M-06-06	3/8"-19	3/8"-19	30	25				
B9M-08-04	1/2"-14	1/4"-19						
B9M-08-06	1/2"-14	3/8"-19	37	33				
B9M-08-08	1/2"-14	1/2"-14	34	32				
B9M-12-08	3/4"-14	1/2"-14	40	35				
B9M-12-12	3/4"-14	3/4"-14	40	34				
B9M-16-12	1"-11	3/4"-14	52	42				
B9M-16-16	1"-11	1"-11	51	50				
B9M-20-16	1-1/4"-11	1"-11						
B9M-20-20	1-1/4"-11	1-1/4"-11	61	61				
B9M-24-24	1-1/2"-11	1-1/2"-11						

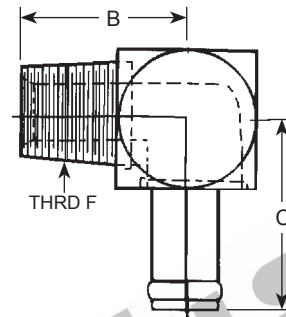

BSPT x LP HOSE TAIL 90° ELBOW

PART NO.	THRD F MALE	HOSE SIZE	DIMENSIONS mm					
			B	C				
BH9M-08-12	1/2"-14	3/4"	34	63				
BH9M-12-12	3/4"-14	3/4"	41	53				
BH9M-12-16	3/4"-14	1"	41	53				
BH9M-12-20	3/4"-14	1 1/4"	48	67				
BH9M-16-12	1" -11	3/4"	51	58				
BH9M-16-16	1" -11	1"	51	60				
BH9M-16-20	1" -11	1 1/4"	54	67				
BH9M-16-24	1" -11	1 1/2"	54	68				
BH9M-20-16	1-1/4"-11	1"	62	66				
BH9M-20-20	1-1/4"-11	1 1/4"	62	67				
BH9M-20-24	1-1/4"-11	1 1/2"	62	68				
BH9M-24-20	1-1/2"-11	1 1/4"	67	68				
BH9M-24-24	1-1/2"-11	1 1/2"	67	68				
BH9M-32-24	2"-11	1 1/2"						
BH9M-32-32	2"-11	2"						

www.hardyspicer.com.au

Document No:	HSYDCAT
Issue:	9
Issue Date:	01/04/12

ADAPTORS

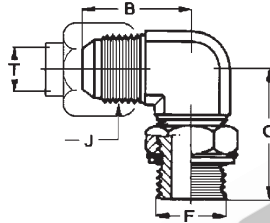

BSPP x JIC 90° ELBOW

PART NO.	THRD F BSPP	THRD J JIC	DIMENSIONS mm		TUBE SIZE	
			B	C	inch	
JP9M-02-07	1/8"-28	7/16"-20			1/4"	
JP9M-02-09	1/8"-28	9/16"-18			3/8"	
JP9M-04-07	1/4"-19	7/16"-20	27.0	31.5	1/4"	
JP9M-04-09	1/4"-19	9/16"-18	27.0	31.5	3/8"	
JP9M-06-07	3/8"-19	7/16"-20			1/4"	
JP9M-06-09	3/8"-19	9/16"-18	28.5	36.5	3/8"	
JP9M-06-12	3/8"-19	3/4"-16	31.5	36.5	1/2"	
JP9M-06-14	3/8"-19	7/8"-14			5/8"	
JP9M-08-09	1/2"-12	9/16"-18			3/8"	
JP9M-08-12	1/2"-12	3/4"-16	34.0	43.0	1/2"	
JP9M-08-14	1/2"-12	7/8"-14	36.5	43.0	5/8"	
JP9M-08-17	1/2"-12	1-1/16"-12	42.0	45.5	3/4"	
JP9M-12-12	3/4"-12	3/4"-16	37.0	49.0	1/2"	
JP9M-12-14	3/4"-12	7/8"-14			5/8"	
JP9M-12-17	3/4"-12	1-1/16"-12	42.0	45.5	3/4"	
JP9M-12-21	3/4"-12	1-5/16"-12			1"	
JP9M-16-17	1"-11	1-1/16"-12			3/4"	
JP9M-16-21	1"-11	1-5/16"-12	46.0	52.0	1"	
JP9M-16-26	1"-11	15/8"-12	52.0	57.0	1-1/4"	
JP9M-20-21	1-1/4"-11	1-5/16"-12	52.0	57.0	1"	
JP9M-20-26	1-1/4"-11	1-5/8"-12	52.0	57.0	1-1/4"	

SEAL INCLUDED

INDENT ONLY

Adaptors

www.hardyspicer.com.au

Document No:	HSHYDCAT
Issue:	9
Issue Date:	01/04/12

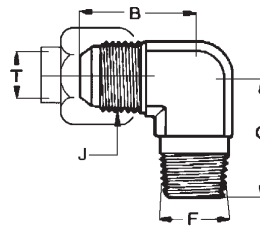

NPT x JIC 90° ELBOW

PART NO.	THRD F NPT	THRD J JIC	DIMENSIONS mm		TUBE SIZE	
			B	C	inch	
JN9M-02-07	1/8"-27	7/16"-20	22.5	19.5	1/4"	
JN9M-02-08	1/8"-27	1/2"-20			5/16"	
JN9M-02-09	1/8"-27	9/16"-18	27.0	23.5	3/8"	
JN9M-04-07	1/4"-18	7/16"-20	27.0	27.5	1/4"	
JN9M-04-08	1/4"-18	1/2"-20			5/16"	
JN9M-04-09	1/4"-18	9/16"-18	27.0	27.5	3/8"	
JN9M-04-12	1/4"-18	3/4"-16	31.5	31.0	1/2"	
JN9M-06-09	3/8"-18	9/16"-18	28.5	31.0	3/8"	
JN9M-06-12	3/8"-18	3/4"-16	31.5	31.0	1/2"	
JN9M-06-14	3/8"-18	7/8"-14	36.5	32.0	5/8"	
JN9M-08-09	1/2"-14	9/16"-18	31.0	37.0	3/8"	
JN9M-08-12	1/2"-14	3/4"-16	34.0	37.0	1/2"	
JN9M-08-14	1/2"-14	7/8"-14	36.5	37.0	5/8"	
JN9M-08-17	1/2"-14	1-1/16"-12	42.0	40.5	3/4"	
JN9M-12-12	3/4"-14	3/4"-16	37.0	40.5	1/2"	
JN9M-12-14	3/4"-14	7/8"-14	39.5	40.5	5/8"	
JN9M-12-17	3/4"-14	1-1/16"-12	42.0	40.5	3/4"	
JN9M-12-21	3/4"-14	1-5/16"-12	46.0	45.0	1"	
JN9M-16-21	1"-11/2	1-5/16"-12	46.0	50.0	1"	
JN9M-16-26	1"-11/2	1-5/8"-12	52.0	59.0	1-1/4"	
JN9M-20-26	1-1/4"-11 1/2	1-5/8"-12	52.0	60.0	1-1/4"	

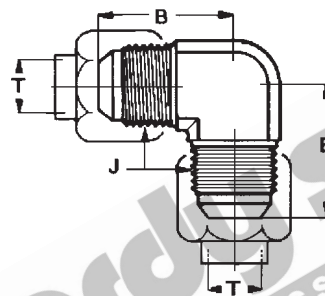

JIC x JIC 90° ELBOW

PART NO.	THRD J	THRD J1	DIMENSIONS mm		TUBE SIZE	
			B		inch	
J9M-07-07	7/16"-20		22.5		1/4"	
J9M-08-08	1/2"-20				5/16"	
J9M-09-09	9/16"-18		27.0		3/8"	
J9M-12-12	3/4"-16		31.5		1/2"	
J9M-14-12	7/8"-14	3/4"-16			5/8"-1/2"	
J9M-14-14	7/8"-14		36.5		5/8"	
J9M-17-14	1-1/16"-12	7/8"-14			3/4"-5/8"	
J9M-17-17	1-1/16"-12		42.0		3/4"	
J9M-21-21	1-5/16"-12		46.0		1"	
J9M-26-26	1-5/8"-12		52.0		1-1/4"	

www.hardyspicer.com.au

Document No:	HSYDCAT
Issue:	9
Issue Date:	01/04/12

INDENT ONLY

ADAPTORS

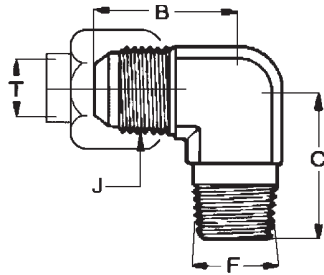

BSPT x JIC 90° ELBOW

PART NO.	THRD F BSPT	THRD J JIC	DIMENSIONS mm			TUBE SIZE	
			B	C		inch	
JB9M-02-07	1/8"-28	7/16"-20	22.5	19.5		1/4"	
JB9M-02-09	1/8"-28	9/16"-18				3/8"	
JB9M-02-08	1/8"-28	1/2"-20				5/16"	
JB9M-04-07	1/4"-19	7/16"-20	27.0	27.5		1/4"	
JB9M-04-08	1/4"-19	1/2"-20				5/16"	
JB9M-04-09	1/4"-19	9/16"-18	27.0	27.5		3/8"	
JB9M-04-12	1/4"-19	3/4"-16	31.5	31.0		1/2"	
JB9M-06-07	3/8"-19	7/16"-20				1/4"	
JB9M-06-09	3/8"-19	9/16"-18	28.5	31.0		3/8"	
JB9M-06-12	3/8"-19	3/4"-16	31.5	31.0		1/2"	
JB9M-06-14	3/8"-19	7/8"-14	36.5	32.0		5/8"	
JB9M-08-09	1/2"-14	9/16"-18	31.0	37.0		3/8"	
JB9M-08-12	1/2"-14	3/4"-16	34.0	37.0		1/2"	
JB9M-08-14	1/2"-14	7/8"-14	36.5	37.0		5/8"	
JB9M-08-17	1/2"-14	1-1/16"-12	42.0	40.5		3/4"	
JB9M-12-09	3/4"-14	9/16"-18				3/8"	
JB9M-12-12	3/4"-14	3/4"-14				1/2"	
JB9M-12-14	3/4"-14	7/8"-14	39.5	40.5		5/8"	
JB9M-12-17	3/4"-14	1-1/16"-12	42.0	40.5		3/4"	
JB9M-12-21	3/4"-14	1-5/16"-12	46.0	45.0		1"	
JB9M-16-17	1"-11	1-1/16"-12	45.0	50.0		3/4"	
JB9M-16-21	1"-11	1-5/16"-12	46	50		1"	
JB9M-16-26	1"-11	1-5/8"-12				1-1/4"	
JB9M-20-21	1-1/4"-11	1-5/16"-12				1"	
JB9M-20-26	1-1/4"-11	1-5/8"-12	52	60		1-1/4"	
JB9M-24-30	1-1/2"-11	1-7/8"-12				1-1/2"	

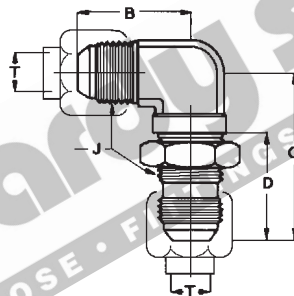

JIC x JIC BULKHEAD 90° ELBOW

PART NO.	THRD J	DIMENSIONS mm			TUBE SIZE	
		B	C	D	inch	
J90M-07-07	7/16"-20	24.5	40.5	28.5	1/4"	
J90M-09-09	9/16"-18	27.5	46.0	30.0	3/8"	
J90M-12-12	3/4"-16	34.5	53.5	35.0	1/2"	
J90M-14-14	7/8"-14	39.5	60.5	38.5	5/8"	
J90M-17-17	1-1/16"-12	45.0	68.0	42.5	3/4"	
J90M-21-21	1-5/16"-12	49.0	71.0	42.5	1"	

INDEXT ONLY

www.hardyspicer.com.au

Document No:	HSHYDCAT
Issue:	9
Issue Date:	01/04/12

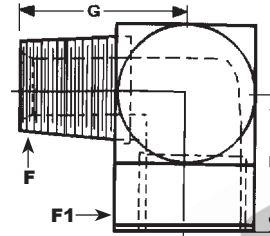

BSPT x BSPT M/F 90° ELBOW

PART NO.	THRD F MALE	THRD F1 FEMALE	DIMENSIONS mm				
			G	H			
B9MF-02-02	1/8"-28	1/8"-28	23.0	16			
B9MF-04-04	1/4"-19	1/4"-19	27.0	22			
B9MF-06-06	3/8"-19	3/8"-19	31.5	22			
B9MF-06-08	3/8"-19	1/2"-14					
B9MF-08-06	1/2"-14	3/8"-19					
B9MF-08-08	1/2"-14	1/2"-14	36.0	32			
B9MF-12-12	3/4"-14	3/4"-14	42.0	37			
B9MF-16-16	1"-11	1"-11	46.0	42			
B9MF-20-20	1-1/4"-11	1-1/4"-11					

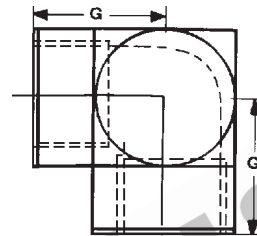

BSPT x BSPT F/F 90° ELBOW

PART NO.	THRD F	DIMENSIONS mm				
		G				
B9F-02-02	1/8"-28					
B9F-04-04	1/4"-19	22				
B9F-06-06	3/8"-19	25				
B9F-08-08	1/2"-14	30				
B9F-12-12	3/4"-14	34				
B9F-16-16	1"-11	42				
B9F-20-20	1-1/4"-11					

www.hardyspicer.com.au

Document No:	HSYDCAT
Issue:	9
Issue Date:	01/04/12

INDENT ONLY

ADAPTORS

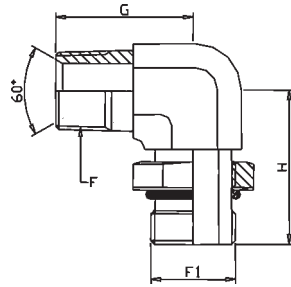

UN 'O' RING x BSPT 90° ELBOW

PART NO.	THRD F1 UNO	THRD F BSPT	DIMENSIONS mm				
			G	H			
BU9M-09-04	9/16"-18	1/4"-19	27.0	31.5			
BU9M-09-06	9/16"-18	3/8"-19	31.5	33.5			
BU9M-12-06	3/4"-16	3/8"-19	31.5	36.5			
BU9M-12-08	3/4"-16	1/2"-14	36.5	39.5			
BU9M-14-06	7/8"-14	3/8"-19	34.0	43.0			
BU9M-14-08	7/8"-14	1/2"-14	36.0	43.0			
BU9M-14-12	7/8"-14	3/4"-14	42.0	45.5			
BU9M-17-08	1-1/16"-12	1/2"-14	39.5	49.0			
BU9M-17-12	1-1/16"-12	3/4"-14	42.0	49.0			
BU9M-21-16	1-5/16"-12	1"-11	46.0	52.0			

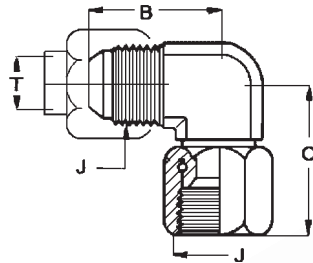

JICM x JICF 90° ELBOW

PART NO.	THRD J	DIMENSIONS mm		TUBE SIZE				
		B	C	inch				
J9MFS-07-07	7/16"-20	22.5	26.0	1/4"				
J9MFS-08-08	1/2"-20							
J9MFS-09-09	9/16"-18	27.0	31.0	3/8"				
J9MFS-12-12	3/4"-16	31.5	31.0	1/2"				
J9MFS-14-14	7/8"-14	36.5	42.0	5/8"				
J9MFS-17-17	1-1/16"-12	42.0	45.5	3/4"				
J9MFS-21-21	1-5/16"-12	46.0	51.5	1"				
J9MFS-26-26	1-5/8"-12	52.0	59.0	1-1/4"				
J9MFS-30-30	1-7/8"-12	59.0	67.0	1-1/2"				

Adaptors

INDENT ONLY

www.hardyspicer.com.au

Document No:	HSHYDCAT
Issue:	9
Issue Date:	01/04/12

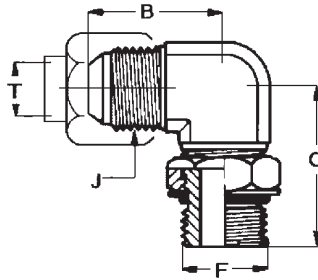

UN 'O' RING x JICM 90° ELBOW

PART NO.	THRD F UNO	THRD J JIC	DIMENSIONS mm			TUBE SIZE	
			B	C	inch		
JU9M-07-07	7/16"-20	7/16"-20	22.5	26.0	1/4"		
JU9M-07-09	7/16"-20	9/16"-18			3/8"		
JU9M-08-09	1/2"-20	9/16"-18			3/8"		
JU9M-09-07	9/16"-18	7/16"-20	27.0	31.5	1/4"		
JU9M-09-09	9/16"-18	9/16"-18	27.0	31.5	3/8"		
JU9M-09-12	9/16"-18	3/4"-16			1/2"		
JU9M-12-09	3/4"-16	9/16"-18	28.5	36.5	3/8"		
JU9M-12-12	3/4"-16	3/4"-16	31.5	31.5	1/2"		
JU9M-12-14	3/4"-16	7/8"-14	36.5	39.5	5/8"		
JU9M-12-17	3/4"-16	1-1/16"-12	42.0	42.0	3/4"		
JU9M-14-09	7/8"-14	9/16"-18			3/8"		
JU9M-14-12	7/8"-14	3/4"-16	34.0	43.0	1/2"		
JU9M-14-14	7/8"-14	7/8"-14	36.5	43.0	5/8"		
JU9M-14-17	7/8"-14	1-1/16"-12	42.0	45.5	3/4"		
#JU9M-17-09	1-1/16"-12	9/16"-18			3/8"		
JU9M-17-12	1-1/16"-12	3/4"-16	37.0	49.0	1/2"		
JU9M-17-14	1-1/16"-12	7/8"-14	39.5	49.0	5/8"		
JU9M-17-17	1-1/16"-12	1-1/16"-12	42.0	49.0	3/4"		
JU9M-17-21	1-1/16"-12	1-5/16"-12	46.0	52.0	1"		
JU9M-21-17	1-5/16"-12	1-1/16"-12	44.5	52.0	3/4"		
JU9M-21-21	1-5/16"-12	1-5/16"-12	46.0	52.0	1"		
JU9M-21-26	1-5/16"-12	1-5/8"-12			1-1/4"		
JU9M-26-26	1-5/8"-12	1-5/8"-12	52.0	57.0	1-1/4"		
JU9M-30-30	1-7/8"-12	1-7/8"-12	59.0	61.0	1-1/2"		

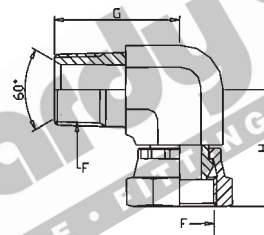

BSPT x BSPP M/F 90° ELBOW

PART NO.	THRD F	DIMENSIONS mm				
		G				
B9MFS-02-02	1/8" - 28	19.8				
B9MFS-04-04	1/4"-19	27.0				
B9MFS-06-06	3/8"-19	31.5				
B9MFS-08-08	1/2"-14	36.5				
B9MFS-12-12	3/4"-14	42.0				
B9MFS-16-16	1"-11	46.0				

INDENT ONLY

www.hardyspicer.com.au

Document No:	HSHYDCAT
Issue:	9
Issue Date:	01/04/12

ADAPTORS

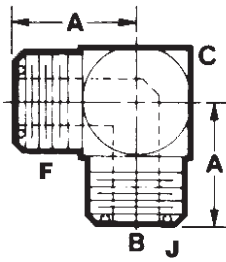

ORFS x ORFS 90° ELBOW

PART NO.	THRD F	THRD J	DIMENSIONS mm			TUBE O.D.		
			A	B	C			
O9M-09-09	9/16" - 18	9/16" - 18	21.8	4.3	16.0	1/4"		
O9M-11-11	11/16" - 16	11/16" - 16	24.9	6.8	19.0	3/8"		
O9M-13-13	13/16" - 16	13/16" - 16	27.9	9.6	22.3	1/2"		
O9M-19-19	1-3/16" - 12	1-3/16" - 12	37.3	15.5	35.0	3/4"		
O9M-23-23	1-7/16" - 12	1-7/16" - 12	41.6	19.8	41.4	1"		

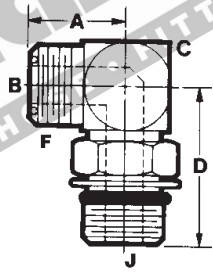

ORFS x UNO 'O' RING 90° ELBOW

PART NO.	THRD F ORFS	THRD J UNO	DIMENSIONS mm				TUBE O.D.		
			A	B	C	D			
OU9M-07-09	9/16" - 18	7/16" - 20	21.8	4.3	16.0	32.5	1/4"		
OU9M-09-11	11/16" - 16	9/16" - 18	24.5	6.8	19.0	36.8	3/8"		
OU9M-12-13	13/16" - 16	3/4" - 16	28.7	9.6	22.3	40.4	1/2"		
OU9M-17-19	1-3/16" - 12	1-1/16" - 12	37.6	15.5	35.0	55.1	3/4"		
OU9M-21-23	1-7/16" - 12	1-5/16" - 12	41.6	20.6	41.4	59.9	1"		

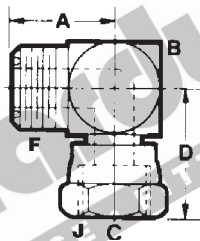

ORFS x ORFS M/F 90° ELBOW

PART NO.	THRD F	THRD J	DIMENSIONS mm				TUBE O.D.		
			A	B	C	D			
O9MFS-09-09	9/16" - 18	9/16" - 18	21.8	16.0	4.3	26.4	1/4"		
O9MFS-11-11	11/16" - 16	11/16" - 16	24.5	19.0	6.6	29.2	3/8"		
O9MFS-13-13	13/16" - 16	13/16" - 16	27.9	22.3	9.1	37.8	1/2"		
O9MFS-19-19	1-3/16" - 12	1-3/16" - 12	37.3	35.0	14.0	46.2	3/4"		
O9MFS-23-23	1-7/16" - 12	1-7/16" - 12	41.6	41.4	19.8	53.3	1"		

INDENT ONLY

www.hardyspicer.com.au

Document No:	HSHYDCAT
Issue:	9
Issue Date:	01/04/12

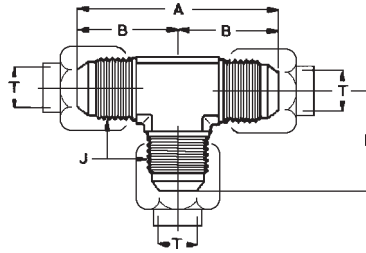

JIC x JIC x JIC M/M/M TEE

PART NO.	THRD J	DIMENSIONS mm		TUBE SIZE	
		A	B	inch	
J5M-07-07-07	7/16"-20	45	22.5	1/4"	
J5M-08-08-08	1/2"-20			5/16"	
J5M-09-09-09	9/16"-18	54	27.0	3/8"	
J5M-12-12-12	3/4"-16	63	31.5	1/2"	
J5M-14-14-14	7/8"-14	73	36.5	5/8"	
J5M-17-17-17	1-1/16"-12	84	42.0	3/4"	
J5M-21-21-21	1-5/16"-12	92	46.0	1"	
J5M-26-26-26	1-5/8"-12	104	52.0	1-1/4"	

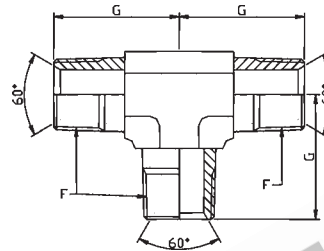

BSPT x BSPT x BSPT M/M/M TEE

PART NO.	THRD F	DIMENSIONS mm			
		G			
B5M-02-02-02	1/8" - 28	19.8			
B5M-04-04-04	1/4"-19	27.0			
B5M-06-06-06	3/8"-19	31.5			
B5M-08-08-08	1/2"-14	36.5			
B5M-12-12-12	3/4"-14	42.0			
B5M-16-16-16	1"-11	46.0			
B5M-20-20-20	1-1/4"-11				

www.hardyspicer.com.au

Document No:	HSYDCAT
Issue:	9
Issue Date:	01/04/12

INDENT ONLY

Adaptors

ADAPTORS

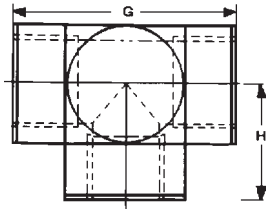

BSPT x BSPT x BSPT F/F/F TEE

PART NO.	THRD F	DIMENSIONS mm		
		G	H	
B5F-02-02-02	1/8" - 28	34	17	
B5F-04-04-04	1/4" - 19	39	24	
B5F-06-06-06	3/8" - 19	51	27	
B5F-08-08-08	1/2" - 14	63	31	
B5F-12-12-12	3/4" - 14	68	37	
B5F-16-16-16	1" - 11	85	42	
B5F-20-20-20	1-1/4" - 11	85	42	
B5F-24-24-24	1-1/2" - 11			

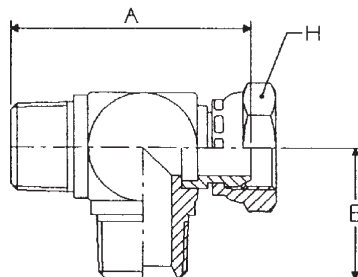

BSPT x BSPP x BSPT M/F/M TEE

PART NO.	THRD F	DIMENSIONS mm		
		A	B	H
B5FSM-02-02-02	1/8" - 28	43.6	19.8	15.9
B5FSM-04-04-04	1/4" - 19	57.5	27.7	19.1
B5FSM-06-06-06	3/8" - 19	63.0	31.0	22.2
B5FSM-08-08-08	1/2" - 14	74.8	37.3	27.0
B5FSM-12-12-12	3/4" - 14	86.7	40.4	31.8
B5FSM-16-16-16	1" - 11	100.0	50.5	41.3
B5FSM-20-20-20	1-1/4" - 11			

INDENT ONLY

www.hardyspicer.com.au

Document No:	HSHYDCAT
Issue:	9
Issue Date:	01/04/12

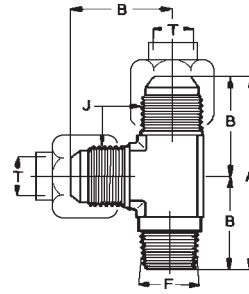

JIC x BSPT x JIC M/M/M TEE

PART NO.	THRD J	THRD F	DIMENSIONS mm			TUBE SIZE	
			A	B	C	inch	
JB5M-07-02-07	7/16"-20	1/8"-28	42.0	22.5	19.5	1/4"	
JB5M-07-04-07	7/16"-20	1/4"-19				1/4"	
JB5M-09-04-09	9/16"-18	1/4"-19	54.5	27.0	27.5	3/8"	
JB5M-09-06-09	9/16"-18	3/8"-19				3/8"	
JB5M-12-06-12	3/4"-16	3/8"-19	62.5	31.5	31.0	1/2"	
JB5M-14-08-14	7/8"-14	1/2"-14	68.5	36.5	32.0	5/8"	
JB5M-17-12-17	1-1/16"-12	3/4"-14	82.5	42.0	40.5	3/4"	
JB5M-21-16-21	1-5/16"-12	1"-11	96.0	46.0	50.0	1"	

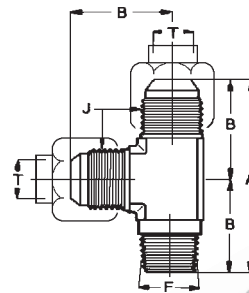

JIC x NPT x JIC M/M/M TEE

PART NO.	THRD J	THRD F	DIMENSIONS mm			TUBE SIZE	
			A	B	C	inch	
JN5M-07-02-07	7/16"-20	1/8"-27	42.0	22.5	19.5	1/4"	
#JN5M-07-04-07	7/16"-20	1/4"-18				1/4"	
JN5M-09-04-09	9/16"-18	1/4"-18	54.5	27.0	27.5	3/8"	
JN5M-12-06-12	3/4"-16	3/8"-18	62.5	31.5	31.0	1/2"	
#JN5M-14-08-14	7/8"-14	1/2"-14	68.5	36.5	32.0	5/8"	
#JN5M-17-12-17	1-1/16"-12	3/4"-14	82.5	42.0	40.5	3/4"	
#JN5M-21-16-21	1-5/16"-12	1"-11 1/2	96.0	46.0	50.0	1"	

www.hardyspicer.com.au

Document No:	HSYDCAT
Issue:	9
Issue Date:	01/04/12

INDENT ONLY

ADAPTORS

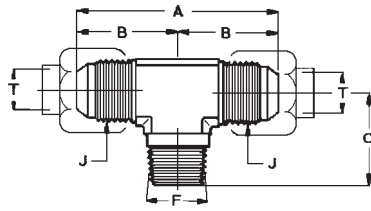

JIC x JIC x BSPT M/M/M TEE

PART NO.	THRD J	THRD F	DIMENSIONS mm			TUBE SIZE	
			A	B	C	inch	
BJ5M-07-07-02	7/16"-20	1/8"-28	45	22.5	19.5	1/4"	
BJ5M-07-07-04	7/16"-20	1/4"-19	54	27.0	27.5	1/4"	
BJ5M-09-09-04	9/16"-18	1/4"-19	54	27.0	27.5	3/8"	
BJ5M-09-09-06	9/16"-18	3/8"-19	57	28.5	31.0	3/8"	
BJ5M-12-12-06	3/4"-16	3/8"-19	63	31.5	31.0	1/2"	
BJ5M-12-12-08	3/4"-16	1/2"-14	68	34.0	37.0	1/2"	
BJ5M-14-14-06	7/8"-14	3/8"-19				5/8"	
BJ5M-14-14-08	7/8"-14	1/2"-14	73	36.5	37.0	5/8"	
BJ5M-14-14-12	7/8"-14	3/4"-14				5/8"	
BJ5M-17-17-12	1-1/16"-12	3/4"-14	84	42.0	40.0	3/4"	
BJ5M-21-21-16	1-5/16"-11	1"-11	92	46.0	50.0	1"	

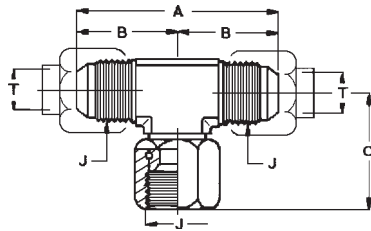

JIC x JIC x JIC M/M/F TEE

PART NO.	THRD J		DIMENSIONS mm			TUBE SIZE	
			A	B	C	inch	
J5MFS-07-07-07	7/16"-20		45	22.5	26.0	1/4"	
J5MFS-09-09-09	9/16"-18		54	27.0	31.0	3/8"	
J5MFS-12-12-12	3/4"-16		63	31.5	35.5	1/2"	
J5MFS-14-14-14	7/8"-14		73	36.5	42.0	5/8"	
J5MFS-17-17-17	1-1/16"-12		84	42.0	45.5	3/4"	
J5MFS-21-21-21	1-5/16"-12		92	46.0	51.5	1"	
J5MFS-26-26-26	1-5/8"-12		104	52.0	59.0	1-1/4"	
#J5MFS-30-30-30	1-7/8"-12		118	59.0	67.0	1-1/2"	

INDENT ONLY

Adaptors

www.hardyspicer.com.au

Document No:	HSHYDCAT
Issue:	9
Issue Date:	01/04/12

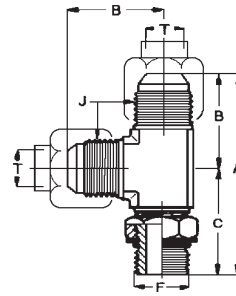

UN 'O' RING x JIC x JIC M/M/M TEE

PART NO.	THRD F UNO	THRD J JIC	DIMENSIONS mm			TUBE SIZE	
			A	B	C	inch	
JU5M-07-07-07	7/16"-20	7/16"-20				1/4"	
JU5M-09-09-09	9/16"-18	9/16"-18	58.5	27.0	31.5	3/8"	
JU5M-12-12-12	3/4"-16	3/4"-16	68.0	31.5	36.5	1/2"	
JU5M-14-12-12	7/8"-14	3/4"-16	77.0	34.0	43.0	1/2"	
JU5M-14-14-14	7/8"-14	7/8"-14	79.5	36.5	43.0	5/8"	
JU5M-17-17-17	1-1/16"-12	1-1/16"-12	91.0	42.0	49.0	3/4"	
JU5M-21-21-21	1-5/16"-12	1-5/16"-12	98.0	46.0	52.0	1"	

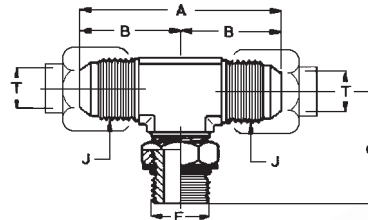

JIC x JIC x UN 'O' RING M/M/M TEE

PART NO.	THRD F UNO	THRD J JIC	DIMENSIONS mm			TUBE SIZE	
			A	B	C	inch	
UJ5M-07-07-07	7/16"-20	7/16"-20				1/4"	
UJ5M-08-08-08	1/2"-20	1/2"-20				5/16"	
UJ5M-09-09-07	7/16"-20	9/16"-18				3/8"	
UJ5M-09-09-09	9/16"-18	9/16"-18	54	27.0	31.5	3/8"	
UJ5M-12-12-12	3/4"-16	3/4"-16	63	31.5	36.5	1/2"	
UJ5M-12-12-14	7/8"-14	3/4"-16	68	34.0	43.0	1/2"	
UJ5M-14-14-14	7/8"-14	7/8"-14	73	36.5	43.0	5/8"	
UJ5M-17-17-17	1-1/16"-12	1-1/16"-12	84	42.0	49.0	3/4"	
UJ5M-21-21-21	1-5/16"-12	1-5/16"-12	92	46.0	52.0	1"	

www.hardyspicer.com.au

Document No:	HSYDCAT
Issue:	9
Issue Date:	01/04/12

INDENT ONLY

ADAPTORS

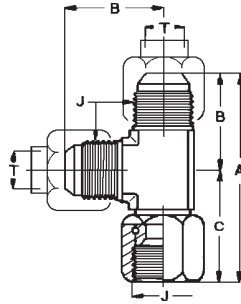

JIC x JIC x JIC M/F/M TEE

PART NO.	THRD J	DIMENSIONS mm			TUBE SIZE	
		A	B	C	inch	
J5FSM-07-07-07	7/16"-20	48.5	22.5	26.0	1/4"	
J5FSM-09-09-09	9/16"-18	58.0	27.0	31.0	3/8"	
J5FSM-12-12-12	3/4"-16	67.0	31.5	35.5	1/2"	
J5FSM-14-14-14	7/8"-14	78.5	36.5	42.0	5/8"	
J5FSM-17-17-17	1-1/16"-12	87.5	42.0	45.5	3/4"	
J5FSM-21-21-21	1-5/16"-12	97.5	46.0	51.5	1"	
J5FSM-26-26-26	1-5/8"-12	111.0	52.0	59.0	1-1/4"	
#J5FSM-30-30-30	1-7/8"-12	126.0	59.0	67.0	1-1/2"	

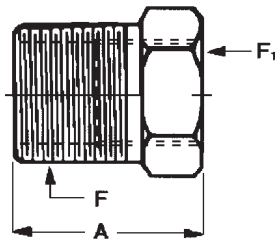

BSPT x BSPT REDUCING BUSH

PART NO.	THRD F	THRD F1	DIMENSIONS mm			
			A			
B1R-04-02	1/4"-19	1/8"-28	17.0			
B1R-06-02	3/8"-19	1/8"-28	18.0			
B1R-06-04	3/8"-19	1/4"-19	18.0			
B1R-08-02	1/2"-14	1/8"-28	21.8			
B1R-08-04	1/2"-14	1/4"-19	21.8			
B1R-08-06	1/2"-14	3/8"-19	21.8			
B1R-12-04	3/4"-14	1/4"-19	23.0			
B1R-12-06	3/4"-14	3/8"-19	23.0			
B1R-12-08	3/4"-14	1/2"-14	23.0			
B1R-16-06	1"-11	3/8"-19	27.8			
B1R-16-08	1"-11	1/2"-14	27.8			
B1R-16-12	1"-11	3/4"-14	27.8			
B1R-20-08	1-1/4"-11	1/2"-14	29.4			
B1R-20-12	1-1/4"-11	3/4"-14	29.4			
B1R-20-16	1-1/4"-11	1"-11	29.4			
B1R-24-12	1-1/2"-11	3/4"-14	31.0			
B1R-24-16	1-1/2"-11	1"-11	31.0			
B1R-24-20	1-1/2"-11	1-1/4"-11	31.0			
B1R-32-20	2"-11	1-1/4"-11	31.0			
B1R-32-24	2"-11	1-1/2"-11	31.0			

www.hardyspicer.com.au

Document No:	HSHYDCAT
Issue:	9
Issue Date:	01/04/12

INDENT ONLY

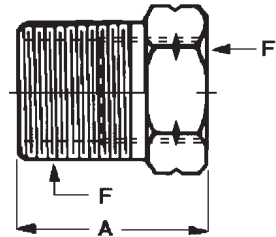

NPT x NPT REDUCING BUSH

PART NO.	THRD F	THRD F1	DIMENSIONS mm			
			A			
N1R-04-02	1/4"-18	1/8"-27	17.0			
N1R-06-02	3/8"-18	1/8"-27	18.0			
N1R-06-04	3/8"-18	1/4"-18	18.0			
N1R-08-02	1/2"-14	1/8"-27	21.8			
N1R-08-04	1/2"-14	1/4"-18	21.8			
N1R-08-06	1/2"-14	3/8"-18	21.8			
N1R-12-04	3/4"-14	1/4"-18	23.0			
N1R-12-06	3/4"-14	3/8"-18	23.0			
N1R-12-08	3/4"-14	1/2"-14	23.0			
N1R-16-08	1"-11 1/2	1/2"-14	27.8			
N1R-16-12	1"-11 1/2	3/4"-14	27.8			
N1R-20-08	1-1/4"-11 1/2	1/2"-14	27.8			
N1R-20-12	1-1/4"-11 1/2	3/4"-14	29.4			
N1R-20-16	1-1/4"-11 1/2	1"-11 1/2	29.4			
N1R-24-16	1-1/2"-11 1/2	1"-11 1/2	29.4			
N1R-24-20	1-1/2"-11 1/2	1-1/4"-11 1/2	29.4			

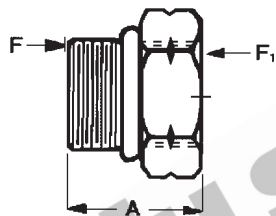

UN 'O' RING x UN 'O' RING REDUCING BUSH

PART NO.	THRD F	THRD F1	DIMENSIONS mm			
			A			
U1R-14-09	7/8"-14	9/16"-18	23			
U1R-17-09	1-1/16"-12	9/16"-18	28			
U1R-17-12	1-1/16"-12	3/4"-16	28			
U1R-21-12	1-5/16"-12	3/4"-16	28			
U1R-21-14	1-5/16"-12	7/8"-14	28			
U1R-21-17	1-5/16"-12	1-1/16"-12	28			
U1R-26-17	1-5/8"-12	1-1/16"-12	30			
U1R-26-21	1-5/8"-12	1-5/16"-12	30			

www.hardyspicer.com.au

Document No:	HSYDCAT
Issue:	9
Issue Date:	01/04/12

INDENT ONLY

ADAPTORS

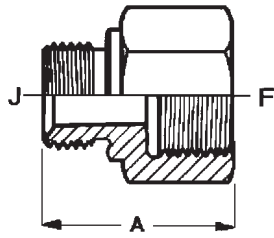

BSPP REDUCING BUSH

PART NO.	THRD J	THRD F	DIMENSIONS mm			
			A			
P1R-04-02	1/4"-19	1/8"-28				
P1R-06-04	3/8"-19	1/4"-19	28			
P1R-08-04	1/2"-14	1/4"-19	22			
P1R-08-06	1/2"-14	3/8"-19	32			
P1R-12-04	3/4"-14	1/4"-19	27			
P1R-12-06	3/4"-14	3/8"-19	27			
P1R-12-08	3/4"-14	1/2"-14	29			
P1R-16-08	1"-11	1/2"-14	30			
P1R-16-12	1"-11	3/4"-14	30			
P1R-20-12	1-1/4"-11	3/4"-14	30			
P1R-20-16	1-1/4"-11	1"-11	30			
P1R-24-12	1-1/2"-11	3/4"-14	35			
P1R-24-16	1-1/2"-11	1"-11	35			
P1R-24-20	1-1/2"-11	1-1/4"-11	60			
P1R-32-20	2"-11	1-1/4"-11	37			
PIR-32-24	2"-11	1-1/2"-11	37			

BONDED SEAL INCLUDED

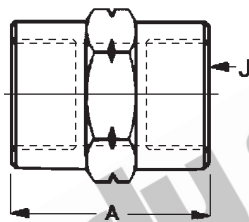

NPT x NPT SOCKET

PART NO.	THRD J	DIMENSIONS mm			
		B			
N1F-02-02	1/8"-27	19			
N1F-04-04	1/4"-18	28			
N1F-06-06	3/8"-18	29			
N1F-08-08	1/2"-14	40			
N1F-12-12	3/4"-14	44			
N1F-16-16	1"-11 1/2	47			
N1F-20-20	1-1/4"-11 1/2	50			
N1F-24-24	1-1/2"-11 1/2				

INDENT ONLY

www.hardyspicer.com.au

Document No:	HSHYDCAT
Issue:	9
Issue Date:	01/04/12

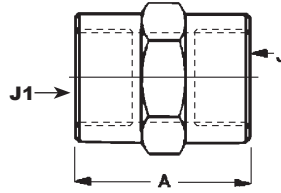

BSPT x BSPT SOCKET

PART NO.	THRD J	THRD J1	DIMENSIONS mm			
			A			
B1F-02-02	1/8"-28	1/8"-28	19			
B1F-04-04	1/4"-19	1/4"-19	28			
B1F-06-04	1/4"-19	3/8"-19				
B1F-06-06	3/8"-19	3/8"-19	29			
B1F-08-08	1/2"-14	1/2"-14	40			
B1F-12-12	3/4"-14	3/4"-14	44			
B1F-16-16	1"-11	1"-11	47			
B1F-20-20	1-1/4"-11	1-1/4"-11	50			
B1F-24-24	1-1/2"-11	1-1/2"-11	80			
B1F-32-32	2"-11	2"-11				

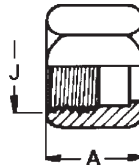

JIC CAP NUT

PART NO.	THRD J	DIMENSIONS mm			TUBE SIZE	
		A			inch	
JCN-07	7/16"-20	18.0			1/4"	
JCN-08	1/2"-20				5/16"	
JCN-09	9/16"-18	22.0			3/8"	
JCN-12	3/4"-16	24.0			1/2"	
JCN-14	7/8"-14	27.0			5/8"	
JCN-17	1-1/16"-12	30.0			3/4"	
JCN-21	1-5/16"-12	31.5			1"	
JCN-26	1-5/8"-12	33.0			1-1/4"	
JCN-30	1-7/8"-12	39.0			1-1/2"	

www.hardyspicer.com.au

Document No:	HSYDCAT
Issue:	9
Issue Date:	01/04/12

INDENT ONLY

ADAPTORS

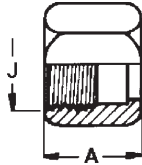

BSPT CAP NUT

PART NO.	THRD J	DIMENSIONS mm				TUBE SIZE	
		A			inch		
BC-02	1/8" - 28						
BC-04	1/4" - 19	18.0					
BC-06	3/8" - 19	22.0			3/8"		
BC-08	1/2" - 14	24.0			1/2"		
BC-12	3/4" - 14	27.0			5/8"		
BC-16	1" - 11	30.0			3/4"		
BC-20	1-1/4" - 11	31.5			1"		
BC-24	1-1/2" - 11	33.0			1-1/4"		
BC-32	2" - 11	39.0			1-1/2"		

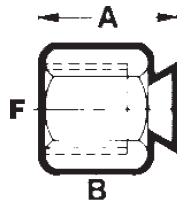

'O' RING FACE SEAL CAP NUT

PART NO.	THRD F	THRD J	DIMENSIONS mm				TUBE O.D.
			A	B	C	D	
OCN-09	9/16" - 18		16.8	17.5			1/4"
OCN-11	11/16" - 16		19.0	20.6			3/8"
OCN-13	13/16" - 16		23.1	23.9			1/2"
OCN-16	1" - 14						5/8"
OCN-19	1-3/16" - 12		27.9	35.0			3/4"
OCN-23	1-7/16" - 12		29.7	41.4			1"
OCN-27	1-11/16" - 12						1-1/4"
OCN-32	2" - 12						1-1/2"

Adaptors

INDENT ONLY

www.hardyspicer.com.au

Document No:	HSHYDCAT
Issue:	9
Issue Date:	01/04/12

Adaptors

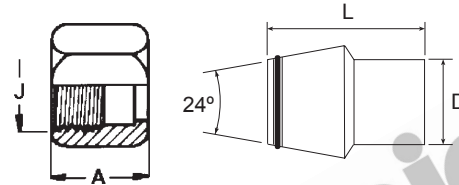

LIGHT METRIC CAP

PART NO.	THRD F	DIMENSIONS mm				
		A	HEX	L	D	
MCL-12	12x1.5	14.8	14	17.2	5.8	
MCL-14	14x1.5	15	17	17	7.8	
MCL-16	16x1.5	15.8	19	20	9.8	
MCL-18	18x1.5	16	22	21	11.8	
MCL-22	22x1.5	17.5	27	21	14.8	
MCL-26	26x1.5	18	32	23	18	
MCL-30	30x2.0	20.5	36	23	22	
MCL-36	36x2.0	21	41	25.2	28	
MCL-45	45x2.0	24.5	50	29	34.8	

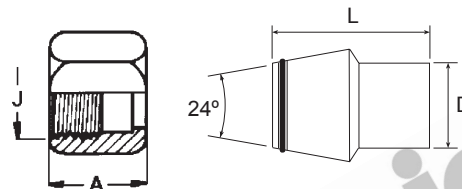

HEAVY METRIC CAP

PART NO.	THRD F	DIMENSIONS mm				
		A	HEX	L	D	
MCH-14	14x1.5	17	17	17.2	5.8	
MCH-16	16x1.5	17	19	17	7.8	
MCH-18	18x1.5	18	22	20	9.8	
MCH-20	20x1.5	17.8	24	21	11.8	
MCH-22	22x1.5	21	27	23	14	
MCH-24	24x1.5	21.6	30	24	16	
MCH-30	30x2.0	24.2	36	28	20	
MCH-36	36x2.0	27.4	46	31	24.8	
MCH-42	42x2.0	29.2	50	34	29.8	

www.hardyspicer.com.au

Document No:	HSYDCAT
Issue:	9
Issue Date:	01/04/12

#INDENT ONLY

ADAPTORS

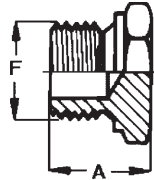

BSPP PLUG

PART NO.	THRD J	DIMENSIONS mm					
		A					
PP-02	1/8"-28						
PP-04	1/4"-19	20					
PP-06	3/8"-19	20					
PP-08	1/2"-14	23					
PP-12	3/4"-14	26					
PP-16	1"-11	28					
PP-20	1-1/4"-11	31					
PP-24	1-1/2"-11	35					
PP-32	2"-11	37					

BONDED SEAL INCLUDED

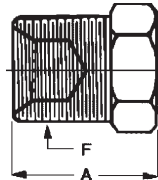

BSPT PLUG

PART NO.	THRD F	DIMENSIONS mm					
		A					
BP-02	1/8"-28	17.0					
BP-04	1/4"-19	18.0					
BP-06	3/8"-19	18.0					
BP-08	1/2"-14	21.8					
BP-12	3/4"-14	23.0					
BP-16	1"-11	27.8					
BP-20	1-1/4"-11	29.4					
BP-24	1-1/2"-11	31.0					
BP-32	2"-11	35.0					

INDENT ONLY

www.hardyspicer.com.au

Document No:	HSHYDCAT
Issue:	9
Issue Date:	01/04/12

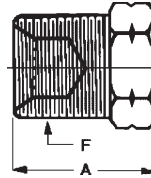

NPT PLUG

PART NO.	THRD F	DIMENSIONS mm			
		A			
NP-02	1/8"-27	17.0			
NP-04	1/4"-18	18.0			
NP-06	3/8"-18	18.0			
NP-08	1/2"-14	21.8			
NP-12	3/4"-14	23.0			
NP-16	1"-11 1/2	27.8			
NP-20	1-1/4"-11 1/2				
NP-24	1-1/2"-11 1/2				
NP-32	2"-11 1/2				

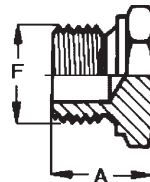

METRIC PLUG (PORT)

PART NO.	THRD F	DIMENSIONS mm			
		A			
MP-12	12x1.5	15			
MP-14	14x1.5	15			
MP-16	16x1.5	15			
MP-18	18x1.5	16			
MP-20	20x1.5				
MP-22	22x1.5	18			
MP-24	24x1.5				
MP-26	26x1.5	18			
MP-27	27x2.0	18			
MP-33	33x2.0	22			
MP-42	42x2.0	22			

METRIC SEALS SOLD SEPARATELY MSR-

www.hardyspicer.com.au

Document No:	HSHYDCAT
Issue:	9
Issue Date:	01/04/12

INDENT ONLY

ADAPTORS

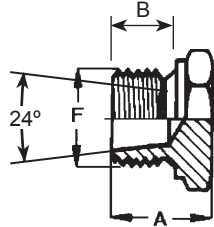

LIGHT METRIC PLUG

PART NO.	THRD F	DIMENSIONS mm					
		A	B	HEX			
MPL-12	12x1.5	14	10	12			
MPL-14	14x1.5	15	10	14			
MPL-16	16x1.5	16	11	17			
MPL-18	18x1.5	17	11	19			
MPL-22	22x1.5	18	12	24			
MPL-26	26x1.5	19	12	27			
MPL-30	30x2.0	21	14	32			
MPL-36	36x2.0	22	14	41			
MPL-45	45x2.0	25	16	46			

METRIC SEALS SOLD SEPARATELY MSR-

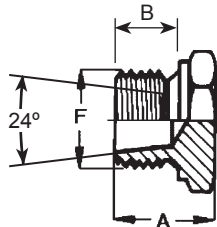

HEAVY METRIC PLUG

PART NO.	THRD F	DIMENSIONS mm					
		A	B	HEX			
MPH-14	14x1.5	18	12	14			
MPH-16	16x1.5	20	12	17			
MPH-18	18x1.5	20	12	19			
MPH-20	20x1.5	22	12	22			
MPH-22	22x1.5	24	14	24			
MPH-24	24x1.5	24	14	27			
MPH-30	30x2.0	28	16	32			
MPH-36	36x2.0	32	18	41			
MPH-42	54x2.0	34	20	46			
MPH-52	52x2.0	39	22	55			

METRIC SEALS SOLD SEPARATELY MSR-

INDENT ONLY

www.hardyspicer.com.au

Document No:	HSHYDCAT
Issue:	9
Issue Date:	01/04/12

Adaptors

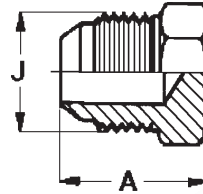

JIC PLUG

PART NO.	THRD J	DIMENSIONS mm			TUBE SIZE	
		A			inch	
JP-07	7/16"-20	20.5			1/4"	
JP-08	1/2"-20				5/16"	
JP-09	9/16"-18	21.5			3/8"	
JP-12	3/4"-16	24.5			1/2"	
JP-14	7/8"-14	28.0			5/8"	
JP-17	1-1/16"-12	32.5			3/4"	
JP-21	1-5/16"-12	34.0			1"	
JP-26	1-5/8"-12	37.0			1-1/4"	
JP-30	1-7/8"-12	42.0			1-1/2"	

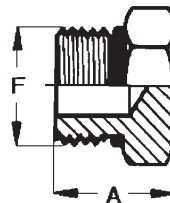

UN 'O' RING PLUG

PART NO.	THRD F	DIMENSIONS mm				
		A				
UP-06	3/8"-24					
UP-07	7/16"-20	11.5				
UP-08	1/2"-20					
UP-09	9/16"-18	12.5				
UP-12	3/4"-16	14.5				
UP-14	7/8"-14	16.5				
UP-17	1-1/16"-12	19.5				
UP-19	1-3/16"-12					
UP-21	1-5/16"-12	19.5				
UP-26	1-5/8"-12	19.5				
UP-30	1-7/8"-12	19.5				

www.hardyspicer.com.au

Document No:	HSYDCAT
Issue:	9
Issue Date:	01/04/12

INDENT ONLY

ADAPTORS

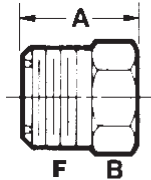

'O' RING FACE SEAL PLUG

PART NO.	THRD F	THRD J	DIMENSIONS mm				TUBE O.D.
			A	B	C	D	
OP-09	9/16" - 18		16.8	16.0			1/4"
OP-11	11/16" - 16		19.0	19.0			3/8"
OP-13	13/16" - 16		21.8	22.3			1/2"
OP-16	1" - 14						5/8"
OP-19	1-3/16" - 12		27.4	31.7			3/4"
OP-23	1-7/16" - 12		27.9	38.1			1"
OP-27	1-11/16" - 12						1-1/4"
OP-32	2" - 12						1-1/2"

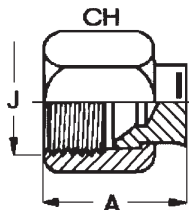

JIC TUBE NUT & SLEEVE

PART NO.	THRD J	DIMENSIONS mm			TUBE SIZE	
		A	CH	A1	T	
JNS-07	7/16"-20	15.5	9/16"	10.5	1/4"	
JNS-08	1/2"-20				5/16"	
JNS-09	9/16"-18	18.5	1-11/16"	12.5	3/8"	
JNS-12	3/4"-16	21.5	7/8"	14.5	1/2"	
JNS-14	7/8"-14	24.5	1"	16.5	5/8"	
JNS-17	1-1/16"-12	26.0	1-1/4"	17.0	3/4"	
JNS-21	1-5/16"-12	28.5	1-1/2"	19.5	1"	
JNS-26	1-5/8"-12	31.0	2"	23.0	1-1/4"	
JNS-30	1-7/8"-12	36.0	2-1/4"	28.5	1-1/2"	

Adaptors

INDENT ONLY

www.hardyspicer.com.au

Document No:	HSHYDCAT
Issue:	9
Issue Date:	01/04/12

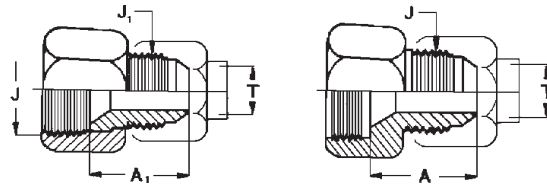

JIC x JIC TUBE REDUCER

PART NO.	THRD J	THRD J1	DIMENSIONS mm		TUBE SIZE	
			A	A1	inch	inch
JTR-09-07	9/16"-18	7/16"-20		24.5	3/8"	1/4"
JTR-12-07	3/4"-16	7/16"-20		25.5	1/2"	1/4"
JTR-12-09	3/4"-16	9/16"-18		25.5	1/2"	3/8"
JTR-14-07	7/8"-14	7/16"-20		26.0	5/8"	1/4"
JTR-14-09	7/8"-14	9/16"-18		26.5	5/8"	3/8"
JTR-14-12	7/8"-14	3/4"-16	25		5/8"	1/2"
JTR-17-07	1-1/16"-12	7/16"-20		27.5	3/4"	1/4"
JTR-17-09	1-1/16"-12	9/16"-18		27.5	3/4"	3/8"
JTR-17-12	1-1/16"-12	3/4"-16		30.5	3/4"	1/2"
JTR-17-14	1-1/16"-12	7/8"-14	29		3/4"	5/8"
JTR-21-12	1-5/16"-12	3/4"-16			1"	1/2"
JTR-21-14	1-5/16"-12	7/8"-14			1"	5/8"
JTR-21-17	1-5/16"-12	1-1/16"-12		37.5	1"	3/4"
JTR-26-21	1-5/8"-12	1-5/16"-12		40.0	1-1/4"	1"
JTR-30-21	1-7/8"-12	1-5/16"-12			1-1/2"	1"
JTR-30-26	1-7/8"-12	1-5/8"-12			1-1/2"	1-1/4"

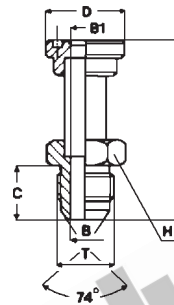

JIC x FLANGE HEAD STR. ADAPTOR 3000 PSI (CODE 61)

PART NO.	THRD T JIC	FLANGE NOMINAL	DIMENSIONS mm				
			L	B	B1	C	H1
JF1M-12-08	3/4"-16	1/2"					
#JF1M-14-08	7/8"-14	1/2"					
#JF1M-14-12	7/8"-14	3/4"					
JF1M-17-12	1-1/16"-12	3/4"	74	15	15	22	27
#JF1M-17-16	1-1/16"-12	1"					
JF1M-21-16	1-5/16"-12	1"	82	20	20	24	34
#JF1M-21-20	1-5/16"-12	1-1/4"					
JF1M-21-24	1-5/16"-12	1-1/2"					
JF1M-26-20	1-5/8"-12	1-1/4"	90	26	26	27	42
JF1M-26-24	1-5/8"-12	1-1/2"					

www.hardyspicer.com.au

Document No:	HSHYDCAT
Issue:	9
Issue Date:	01/04/12

INDENT ONLY

ADAPTORS

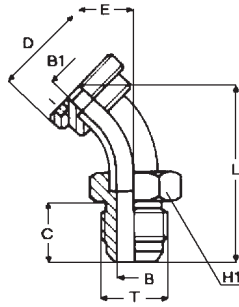

JIC x FLANGE HEAD 45° ADAPTOR 3000 PSI (CODE 61)

PART NO.	THRD T JIC	FLANGE D NOMINAL	DIMENSIONS mm					
			L	B	B1	C	H1	E
JF4M-12-08	3/4"-16	1/2"	60	9.5	12	18	22	19
#JF4M-14-12	7/8"-14	3/4"						
#JF4M-14-16	7/8"-14	1"						
#JF4M-14-20	7/8"-14	1-1/4"						
JF4M-17-12	1-1/16"-12	3/4"	68	15	15	22	27	21
JF4M-17-16	1-1/16"-12	1"						
JF4M-17-16	1-5/16"-12	1"	80	20	20	24	34	23
#JF4M-21-20	1-5/16"-12	1-1/4"						
JF4M-26-20	1-5/16"-12	1-1/4"	93	26	26	27	42	29

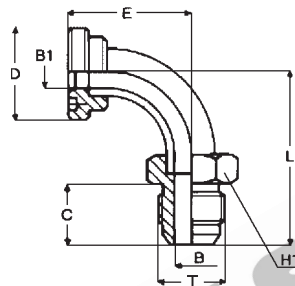

JIC x FLANGE HEAD 90° ADAPTOR 3000 PSI SAE (CODE 61)

PART NO.	THRD T JIC	FLANGE D NOMINAL	DIMENSIONS mm					
			L	B	B1	C	E	H1
#JF9M-12-08	3/4"-16	1/2"	53	9.5	12	18	39	22
#JF9M-12-16	3/4"-16	1"						
#JF9M-14-12	7/8"-14	3/4"						
#JF9M-14-16	7/8"-14	1"						
#JF9M-14-20	7/8"-14	1-1/4"						
JF9M-17-12	1-1/16"-12	3/4"	63	15	15	22	45	27
#JF9M-17-16	1-1/16"-12	1"						
JF9M-17-20	1-1/16"-12	1-1/4"						
JF9M-21-16	1-5/16"-12	1"	75	20	20	24	53	34
#JF9M-21-20	1-5/16"-12	1-1/4"						
JF9M-26-20	1-5/8"-12	1-1/4"	84	26	26	27	58	42

#INDENT ONLY

www.hardyspicer.com.au

Document No:	HSHYDCAT
Issue:	9
Issue Date:	01/04/12

Adaptors

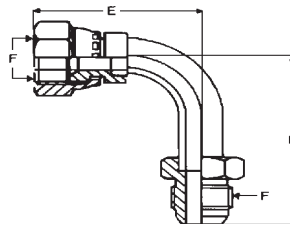

JIC x JIC M/F 90° TUBE BEND

PART NO.	THRD F	DIMENSIONS mm			
		L	E		
JST9MFS-07-07	7/16"-20				
JST9MFS-09-09	9/16"-18				
JST9MFS-12-12	3/4"-16	50	50		
JST9MFS-14-14	7/8"-14	65	65		
JST9MFS-17-17	1-1/16"-12	65	65		
JST9MFS-21-21	1-5/16"-12	75	75		
JST9MFS-26-26	1-5/8"-12	71	105		

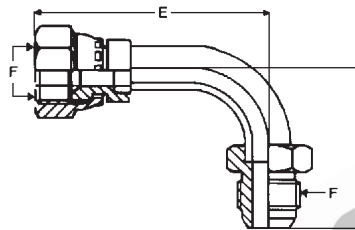

JIC x JIC M/F 90° LONG TUBE BEND

PART NO.	THRD F	DIMENSIONS mm			
		L	E		
JLT9MFS-07-07	7/16"-20				
JLT9MFS-09-09	9/16"-18				
JLT9MFS-12-12	3/4"-16				
JLT9MFS-14-14	7/8"-14				
JLT9MFS-17-17	1-1/16"-12	110	65		
JLT9MFS-21-21	1-5/16"-12	125	74		

www.hardyspicer.com.au

Document No:	HSYDCAT
Issue:	9
Issue Date:	01/04/12

INDENT ONLY

ADAPTORS

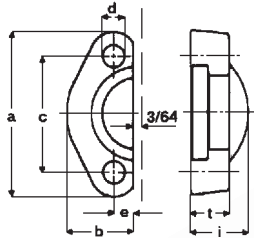

SAE FLANGE 3000 PSI (CODE 61)

PART NO.	FLANGE NOMINAL	DIMENSIONS mm					
		A	B	C	D	E	F
SFK-08	1/2"	54.0	23.0	38.1	9.0	8.7	12.7
SFK-12	3/4"	65.1	26.1	47.6	11.0	11.1	14.3
SFK-16	1"	69.1	29.4	52.4	11.0	13.1	14.3
SFK-20	1-1/4"	79.4	36.5	58.7	11.0	15.1	14.3
SFK-24	1-1/2"	93.7	41.3	69.8	13.5	17.8	15.9
SFK-32	2"	101.6	48.4	77.8	13.5	21.4	15.9
SFK-40	2-1/2"						
SFK-48	3"						

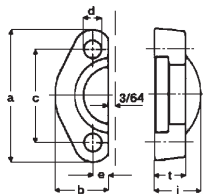

SAE FLANGE 6000 PSI (CODE 62)

PART NO.	FLANGE NOMINAL	DIMENSIONS mm					
		A	B	C	D	E	F
SFHK-12	3/4"	71.4	30.2	50.8	11.0	11.9	19.0
SFHK-16	1"	80.9	34.9	57.1	13.9	15.0	24.0
SFHK-20	1-1/4"	95.2	38.9	66.7	15.0	15.8	27.0
SFHK-24	1-1/2"	112.7	47.6	79.4	17.0	18.2	30.5
SFHK-32	2"	133.3	57.1	96.8	21.0	22.2	36.5

Adaptors

INDENT ONLY

www.hardyspicer.com.au

Document No:	HSHYDCAT
Issue:	9
Issue Date:	01/04/12

Adaptors

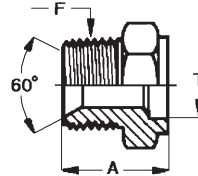

BSPT TUBE WELD NIPPLE

PART NO.	THRD F BSPT	TUBE SIZE inch	DIMENSIONS mm				
			A	T			
B25M-04-04	1/4"-19	1/4"	19.0	6.0			
B25M-04-06	1/4"-19	3/8"	19.0	10.5			
B25M-06-04	3/8"-19	1/4"	21.0	6.0			
B25M-06-06	3/8"-19	3/8"	24.5	10.5			
B25M-08-08	1/2"-14	1/2"	28.5	12.7			
B25M-12-12	3/4"-11	3/4"	33.0	19.5			
B25M-12-16	3/4"-11	1"	30.0	25.5			
B25M-16-16	1"-11	1"	35.0	25.5			
B25M-16-20	1"-11	1-1/4"	33.0	32.5			
B25M-20-20	1-1/4"-11	1-1/4"	37.0	32.5			

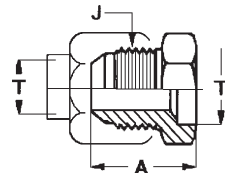

JIC TUBE WELD NIPPLE

PART NO.	THRD J JIC	TUBE SIZE inch	DIMENSIONS mm		TUBE SIZE	
			A	T1	inch	
J25M-07-04	7/16"-20	1/4"	20.5	6.5	1/4"	
J25M-09-04	9/16"-18	1/4"	21.5	6.5	3/8"	
J25M-09-06	9/16"-18	3/8"	21.5	9.6	3/8"	
J25M-09-08	9-16"-18	1/2"	21.5	12.8	3/8"	
J25M-12-06	3/4"-16	3/8"	24.5	9.6	1/2"	
J25M-12-08	3/4"-16	1/2"	24.5	12.8	1/2"	
J25M-12-10	3/4"-16	5/8"	24.5	16.1	1/2"	
J25M-14-08	7/8"-14	1/2"	28.0	12.8	5/8"	
J25M-14-10	7/8"-14	5/8"	28.0	16.1	5/8"	
J25M-14-12	7/8"-14	3/4"	28.0	19.2	5/8"	
J25M-17-12	1-1/16"-12	3/4"	32.5	19.2	3/4"	
J25M-17-16	1-1/16"-12	1"	32.5	25.5	3/4"	
J25M-21-16	1-5/16"-12	1"	34.0	25.5	1"	
J25M-21-20	1-5/16"-12	1-1/4"	34.5	32.5	1"	
J25M-26-20	1-5/8"-12	1-1/4"	37.0	32.5	1-1/4"	
J25M-26-24	1-5/8"-12	1-1/2"	37.0	38.5	1-1/4"	
#J25M-30-24	1-7/8"-12	1-1/2"	42.0	38.5	1-1/2"	

www.hardyspicer.com.au

Document No:	HSYDCAT
Issue:	9
Issue Date:	01/04/12

INDENT ONLY

ADAPTORS

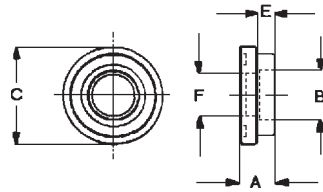

3000 PSI TUBE WELD FLANGE

PART NO.	FLANGE NOMINAL SIZE inch	TUBE SIZE inch	DIMENSIONS mm				
			A	B	C	E	F
F25M-08-08	1/2"	1/2"	12.7	12.7	30.1	6.4	10.3
F25M-12-08	3/4"	1/2"	14.3	12.7	38.1	6.4	10.3
F25M-12-10	3/4"	5/8"	14.3	16.0	38.1	6.4	12.7
F25M-12-12	3/4"	3/4"	14.3	19.0	38.1	6.4	16.0
F25M-12-16	3/4"	1"	14.3	25.4	38.1	6.4	21.4
F25M-16-08	1"	1/2"	14.3	12.7	44.5	6.4	10.3
F25M-16-10	1"	5/8"	14.3	16.0	44.5	6.4	12.7
F25M-16-12	1"	3/4"	14.3	19.0	44.5	6.4	16.0
F25M-16-16	1"	1"	14.3	25.4	44.5	6.4	21.4
F25M-16-20	1"	1-1/4"	14.3	32.0	44.5	6.4	27.8
F25M-20-16	1-1/4"	1"	14.3	25.4	50.8	6.4	21.4
F25M-20-20	1-1/4"	1-1/4"	14.3	32.0	50.8	6.4	27.8
F25M-20-24	1-1/4"	1-1/2"	14.3	38.0	50.8	6.4	33.3
F25M-24-16	1-1/2"	1"	15.9	25.4	60.3	7.9	21.4
F25M-24-20	1-1/2"	1-1/4"	15.9	32.0	60.3	7.9	27.8
F25M-24-24	1-1/2"	1-1/2"	15.9	38.0	60.3	7.9	33.3
F25M-32-20	2"	1-1/4"	15.9	32.0	71.4	7.9	27.8
F25M-32-24	2"	1-1/2"	15.9	38.0	71.4	7.9	33.3
F25M-32-32	2"	2"	15.9	50.8	71.4	7.9	46.0
F25M-40-40	2-1/2"	2-1/2"	18.0	63.5	84.1	7.9	54.0

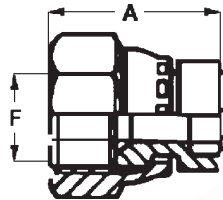

JIC FEMALE SWIVEL TUBE WELD

PART NO.	THRD F JIC	TUBE SIZE inch	DIMENSIONS mm				
			A				
J25FS-07-04	7/16"-20	1/4"					
J25FS-09-04	9/16"-18	1/4"					
J25FS-09-06	9/16"-18	3/8"					
J25FS-09-08	9/16"-18	1/2"					
J25FS-10-06	5/8"-18	3/8"					
J25FS-12-06	3/4"-16	3/8"					
J25FS-12-08	3/4"-16	1/2"					
J25FS-14-08	7/8"-14	1/2"					
J25FS-14-10	7/8"-14	5/8"					
J25FS-17-12	1-1/16"-12	3/4"					
J25FS-17-14	1-1/16"-12	7/8"					
J25FS-17-16	1-1/16"-12	1"					
J25FS-21-16	1-5/16"-12	1"					
J25FS-21-20	1-5/16"-12	1-1/4"					
J25FS-26-20	1-5/8"-12	1-1/4"					
J25FS-30-24	1-7/8"-12	1-1/2"					
J25FS-40-32	2-1/2"-12	2"					

INDENT ONLY

Adaptors

www.hardyspicer.com.au

Document No:	HSHYDCAT
Issue:	9
Issue Date:	01/04/12

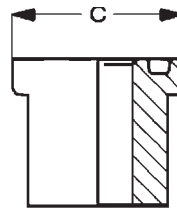

6000 PSI TUBE WELD FLANGE

PART NO.	FLANGE NOMINAL	DIMENSIONS mm			
		C			
FH25M-12	3/4"	41.3			
FH25M-16	1"	47.6			
FH25M-20	1-1/4"	54.0			
FH25M-24	1-1/2"	63.5			
FH25M-32	2"	79.4			

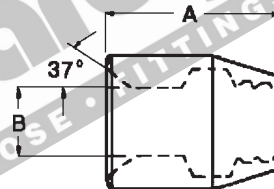

FLARELESS FERRULE

PART NO.	DIMENSIONS mm			TUBE SIZE	
	A	B		inch	
FF-04	10.7	6.4		1/4"	
FF-06	11.9	9.5		3/8"	
FF-08	14.5	12.7		1/2"	
FF-10	14.7	16.0		5/8"	
FF-12	17.8	19.0		3/4"	
FF-16	31.4	25.4		1"	
FF-20				1-1/4"	

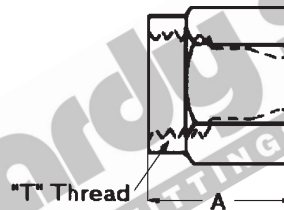

FLARELESS TUBE NUT

PART NO.	THR D T	DIMENSIONS mm			TUBE SIZE	
		A			inch	
FN-04	7/16"-20	20.8			1/4"	
FN-06	9/16"-18	21.8			3/8"	
FN-08	3/4"-16	27.4			1/2"	
FN-10	7/8"-14	28.4			5/8"	
FN-12	1-1/16"-12	34.5			3/4"	
FN-16	1-5/16"-12	35.6			1"	
FN-20	1-5/8"-12				1-1/4"	

www.hardyspicer.com.au

Document No:	HSHYDCAT
Issue:	9
Issue Date:	01/04/12

INDENT ONLY

ADAPTORS

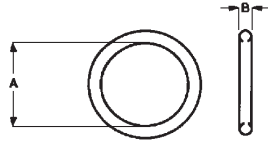

'O' RING TO SUIT SAE FLANGE DUROMETER 90

PART NO.	FLANGE NOMINAL SIZE inch	DIMENSIONS mm			
		A	B		
FOR-08	1/2"	18.64	3.53		
FOR-10	5/8"		3.53		
FOR-12	3/4"	24.99	3.53		
FOR-16	1"	32.92	3.53		
FOR-20	1-1/4"	37.69	3.53		
FOR-24	1-1/2"	47.22	3.53		
FOR-32	2"	54.74	3.53		
FOR-40	2-1/2"	69.44	3.53		

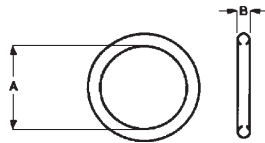

'O' RING TO SUIT UN THREAD DUROMETER 90

PART NO.	THREAD SIZE inch	DIMENSIONS mm			
		A	B		
UOR-07	7/16"	8.9	1.90		
UOR-09	9/16"	11.9	1.98		
UOR-12	3/4"	16.4	1.98		
UOR-14	7/8"	19.2	2.46		
UOR-17	1-1/16"	23.5	2.94		
UOR-21	1-5/16"	29.7	2.94		
UOR-26	1-5/8"	37.5	2.99		
UOR-30	1-7/8"	43.7	2.99		

Adaptors

INDENT ONLY

www.hardyspicer.com.au

Document No:	HSHYDCAT
Issue:	9
Issue Date:	01/04/12

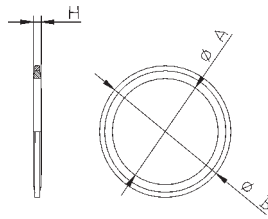

METRIC BONDED SEAL

PART NO.	THREAD SIZE	DIMENSIONS mm		
		A	B	H
MSR-10	10	10	15	4.5
MSR-12	12	12	17	4.5
MSR-14	14	14	19	4.5
MSR-16	16	16	21	4.5
MSR-18	18	18	23	4.5
MSR-20	20	20	25	4.5
MSR-22	22	22	27	4.5
MSR-24	24	24	29	4.5
MSR-26	26	26	31	4.5
MSR-27	27	27	32	5.5
MSR-30	30	30		
MSR-33	33	33	39	6.0
MSR-42	42	42	49	6.5
MSR-48	48	48	55	6.5

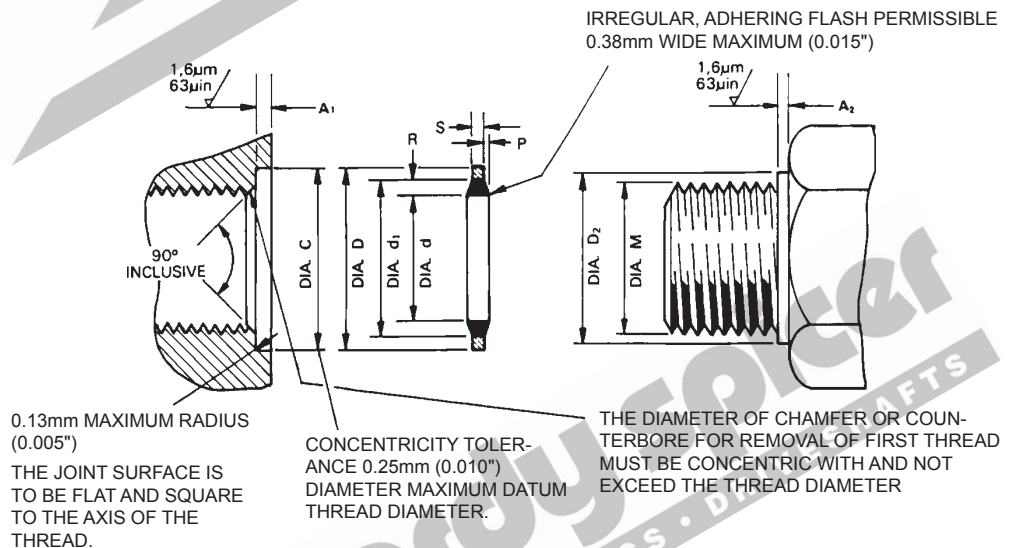

IMPERIAL BONDED SEAL

PART No.	THREAD DIA 'M B.S.P.F.	BONDED SEAL						D +0.5	A A ₁ max A ₂ min	C +0.4	MINIMUM BURST PRESSURE BAR
		D -0.2	d +0.2	d +0.2	S ±0.25	R ±0.2	P +0.25 -0.000				
BS-02	1/8"	14.7	10.40	12.00	1.25	1.35	0.25	14	1.0	15	930
BS-04	1/4"	18.7	13.85	15.75	1.25	1.47	0.25	18	1.5	19	793
BS-06	3/8"	22.7	17.35	19.25	1.25	1.72	0.25	22	2.0	23	775
BS-08	1/2"	26.7	21.65	23.55	1.25	1.57	0.25	26	2.5	27	586
BS-10	5/8"										
BS-12	3/4"	32.5	27.30	29.20	1.25	1.65	0.25	32	2.5	33	500
BS-16	1"	39.5	34.20	36.10	2.00	1.70	0.25	39	2.5	40	414
BS-20	1-1/4"	49.5	42.80	44.70	2.00	2.40	0.25	49	2.5	50	500
BS-24	1-1/2"	55.5	48.70	50.60	2.00	2.45	0.25	55	2.5	56	434
BS-32	2"	68.5	60.50	62.40	2.00	3.05	0.25	68	3.0	69	448

www.hardyspicer.com.au

Document No:	HSYDCAT
Issue:	9
Issue Date:	01/04/12

INDENT ONLY

ADAPTORS

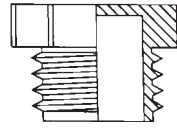
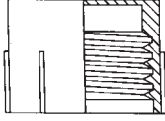

BSP PLASTIC CAPS & PLUGS

BSP PLASTIC CAPS			BSP PLASTIC PLUGS		
PART No.	THRD	COMMENTS	PART No.	THRD	COMMENTS
PBC-04	1/4"		PBP-04	1/4"	
PBC-06	3/8"		PBP-06	3/8"	
PBC-08	1/2"		PBP-08	1/2"	
PBC-12	3/4"		PBP-12	3/4"	
PBC-16	1"		PBP-16	1"	
PBC-20	1-1/4"		PBP-20	1-1/4"	
PBC-24	1-1/2"		PBP-24	1-1/2"	
PBC-32	2"		PBP-32	2"	

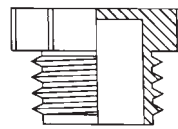
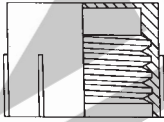

JIC PLASTIC CAPS & PLUGS

JIC PLASTIC CAPS			JIC PLASTIC PLUGS		
PART No.	THRD	COMMENTS	PART No.	THRD	COMMENTS
PJC-07	7/16"-20		PJP-07	7/16"-20	
PJC-09	9/16"-18		PJP-09	9/16"-18	
PJC-12	3/4"-16		PJP-12	3/4"-16	
PJC-14	7/8"-14		PJP-14	7/8"-14	
PJC-17	1-1/16"-12		PJP-17	1-1/16"-12	
PJC-21	1-5/16"-12		PJP-21	1-5/16"-12	
PJC-26	1-5/8"-12		PJP-26	1-5/8"-12	
PJC-30	1-7/8"-12		PJP-30	1-7/8"-12	

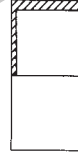
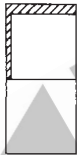

FLANGE PLASTIC COVERS

CODE 61 PLASTIC COVERS			CODE 62 PLASTIC COVERS		
PART No.	FLANGE SIZE	COMMENTS	PART No.	FLANGE SIZE	COMMENTS
P3F-12	3/4"		P6F-12	3/4"	
P3F-16	1"		P6F-16	1"	
P3F-20	1-1/4"		P6F-20	1-1/4"	
P3F-24	1-1/2"		P6F-24	1-1/2"	
P3F-32	2"		P6F-32	2"	

www.hardyspicer.com.au

Document No:	HSHYDCAT
Issue:	9
Issue Date:	01/04/12