

INDEX

SECTION B:3

MECHANICS TYPE C

SERIES	SECTION
UNIVERSAL JOINT TORQUE RANGE	B:3-ii
DIMENSIONAL DATA.....	B:3-iii
2C	B:3-1
3C	B:3-5
4C	B:3-9
5C	B:3-13
6C	B:3-19
7C	B:3-27
8C	B:3-35
8-5C	B:3-39
9C	B:3-45
9-5C	B:3-51
10C	B:3-53
10-5C	B:3-59
11C STANDARD	B:3-61
11C KOMATSU	B:3-65
12C	B:3-67
12-5C	B:3-71
14C	B:3-73
14-5C	B:3-77
15C	B:3-81
15-5C	B:3-87
20C	B:3-89
DRIVE TUBE.....	B:3-90
BEARING CAP BOLTS.....	B:3-92

www.hardyspicer.com.au

Document No:	HSDSCAT
Issue:	8
Issue Date:	01/07/17

MECHANICS UNIVERSAL JOINT TORQUE RANGE

SERIES	E	F	C	American Style		Tcs (Euro Style)	
				CONTINUOUS	SHORT DURATION	FUNCTIONAL LIMIT TORQUE	
2C	33.34	59.44	13.21	169Nm <i>125 ft/lbs</i>	813Nm <i>600 ft/lbs</i>	1490Nm <i>1099 ft/lbs</i>	
3C	36.52	69.85	15.50	291Nm <i>215 ft/lbs</i>	1152Nm <i>850 ft/lbs</i>		
4C	35.52	87.32	15.50	373Nm <i>275 ft/lbs</i>	1423Nm <i>1050 ft/lbs</i>	3280Nm <i>2419 ft/lbs</i>	
5C	42.85	88.90	17.53	644Nm <i>475 ft/lbs</i>	2033Nm <i>1500 ft/lbs</i>	5650Nm <i>5332 ft/lbs</i>	
6C	42.85	114.30	17.53	779Nm <i>575 ft/lbs</i>	2644Nm <i>1950 ft/lbs</i>	7230Nm <i>4167 ft/lbs</i>	
7C	49.21	117.60	20.57	1220Nm <i>900 t/lbs</i>	4203Nm <i>3100 ft/lbs</i>	10700Nm <i>7892 ft/lbs</i>	
8C	49.21	174.63	20.57	1796Nm <i>1325 ft/lbs</i>	6440Nm <i>4750 ft/lbs</i>	15500Nm <i>11432 ft/lbs</i>	
8-5C	71.44	123.83	25.40	2067Nm <i>1525 ft/lbs</i>	9422Nm <i>6950 ft/lbs</i>	20300Nm <i>14972 ft/lbs</i>	
9C	71.44	168.30	25.40	2813Nm <i>2075 ft/lbs</i>	12202Nm <i>9000 ft/lbs</i>	27400Nm <i>20209 ft/lbs</i>	
9-5C	71.44	168.30	28.14	3694Nm <i>2725 ft/lbs</i>	14236Nm <i>10500 ft/lbs</i>		
10C	92.07	165.10	32.51	4338Nm <i>3200 ft/lbs</i>	20337Nm <i>15000 ft/lbs</i>	39700Nm <i>29281 ft/lbs</i>	
10-5C	88.90	172.72	34.04	4338Nm <i>3200 ft/lbs</i>	20337Nm <i>15000 ft/lbs</i>		
11C STANDARD	88.90	172.72	40.13	5965Nm <i>4400 ft/lbs</i>	26438Nm <i>19500 ft/lbs</i>	41600Nm <i>30682 ft/lbs</i>	
11C KOMATSU	88.90	172.72	34.00			41600Nm <i>30682 ft/lbs</i>	
12C	92.20	241.30	32.51	4745Nm <i>3499 ft/lbs</i>	23726Nm <i>17497 ft/lbs</i>	62200Nm <i>45876 ft/lbs</i>	
12-5C	92.00	227.00	38.00			82800Nm <i>61070 ft/lbs</i>	
14C	135.00	270.00	49.00			120600Nm <i>88950 ft/lbs</i>	
14-5C	107.00	252.00	44.00			108200Nm <i>79804 ft/lbs</i>	
15C	99.97	199.95	38.10	9084Nm <i>6700 ft/lbs</i>	27116Nm <i>20000 ft/lbs</i>	75400Nm <i>55612 ft/lbs</i>	
15-5C	99.97	199.95	38.10	10033Nm <i>7400 ft/lbs</i>	35251Nm <i>26000 ft/lbs</i>		
20C	117.60	277.10	48.40	18304Nm <i>13500 ft/lbs</i>	54233Nm <i>40000 ft/lbs</i>		

Tcs Functional Torque Limit is defined as "Up to the maximum permissible torque a load may be applied to the shaft for a limited frequency without the working capability being affected by permanent deformation of any area. Up to 1000 load changes are capable of being sustained with Tcs."

Continuous Torque ratings are based on 2000 RPM at 3° to give approximately 3000 hours, presuming uniform power transmission and the correct maintenance schedule is adhered to.

Short Duration Torque ratings are the maximum recommended values for use in off road applications. If these values are exceeded the universal life hours will be reduced and the matching components may be inadequate.

www.hardyspicer.com.au

Document No:	HSDSCAT
Issue:	8
Issue Date:	01/07/17

MECHANICS DIMENSIONAL DATA

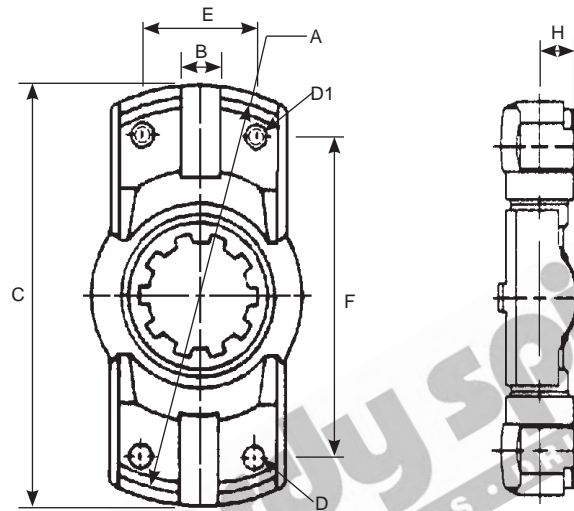

DIMENSIONAL DATA

SERIES	LOCATING SPIGOT		KEY WIDTH		SWING O.D.		DRILLED HOLES		THREADED HOLES		BOLT CENTRES		CENTRE TO FACE OF U/J	
	A		B		C		D		D1		E	F	H	
2C	79.35		9.65		84.84		8.60		5/16" - 24		33.34	59.44	13.21	
		3.125		0.380		3.340		0.338			1.313	2.340		0.520
3C	90.42		9.65		96.77		8.60		5/16" - 24		36.52	69.85	15.50	
		3.560		0.380		3.810		0.338			1.437	2.750		0.610
4C	107.95		9.65		114.30		8.60		5/16" - 24		36.52	87.32	15.50	
		4.250		0.380		4.500		0.338			1.437	3.438		0.610
5C	115.06		14.27		121.41		10.40		3/8" - 24		42.85	88.90	17.53	
		4.530		0.562		4.780		0.410			1.687	3.500		0.690
6C	140.46		14.27		148.34		10.40		3/8" - 24		42.85	114.30	17.53	
		5.530		0.562		5.840		0.410			1.687	4.500		0.690
7C	148.34		15.87		157.99		11.94		1/2" - 20		49.21	117.60	20.57	
		5.840		0.625		6.220		0.470			1.437	4.630		0.810
8C	206.25		15.87		215.90		11.94		1/2" - 20		49.21	174.63	20.57	
		8.120		0.625		8.500		0.470			1.437	6.875		0.810
8-5C	165.10		15.87		174.63		13.46		1/2" - 20		71.44	123.83	25.40	
		6.500		0.625		6.875		0.530			2.813	4.875		1.000
9C	209.55		15.87		219.08		13.46		1/2" - 20		71.44	168.30	25.40	
		8.250		0.625		8.625		0.530	M12x1.75		2.813	6.625		1.000
9-5C	209.55		15.87		219.08		13.46		1/2" - 20		71.44	168.30	28.14	
		8.250		0.625		8.625		0.530			2.813	6.625		1.108
10C	212.85		25.40		225.55		13.46		5/8" - 18		92.07	165.10	32.51	
		8.380		1.000		8.880		0.530	M16x2		3.625	6.500		1.280
10-5C	222.25		25.40		234.95		16.76		5/8" - 18		88.90	172.72	34.04	
		8.750		1.000		9.250		0.660			3.500	6.800		1.340
11C STANDARD	209.55		25.40		234.95				3/4" - 16		88.90	172.72	40.13	
		8.250		1.000		9.250					3.500	6.800		1.580
11C KOMATSU	209.55		25.40		234.95				3/4" - 16		88.90	172.72	34.00	
		8.250		1.000		9.250					3.500	6.800		1.339
12C	288.93		25.40		301.75				M14x1.5		92.20	241.30	32.51	
		11.375		1.000		11.880					3.630	9.500		1.280
12-5C	280.00		35.00		295.00				M18x1.5		92.00	227.00	38.00	
		11.024		1.378		11.614					3.622	8.937		1.496
14C	338.80		28.60		360.00				M18x1.5		135.00	270.00	49.00	
		13.339		1.125		14.173					5.315	10.630		1.929
14-5C	310.00		44.00		326.00		23.50		M22x1.5		107.00	252.00	44.00	
		12.205		1.732		12.835		0.925			4.213	9.921		1.732
15C	259.84		31.75		273.05		16.76		3/4" - 16		99.97	199.985	38.10	
		10.230		1.250		10.750		0.660	M20x2.5		3.936	8.872		1.500
15-5C	259.84		31.75		273.05		16.76		3/4" - 16		99.97	199.985	38.10	
		10.230		1.250		10.750		0.660	M20x2.5		3.936	8.872		1.500
20C	342.90		48.26		357.60				M24x3		117.60	277.10	48.40	
		13.500		1.900		14.079					4.630	10.909		1.906

www.hardyspicer.com.au

Document No:	HSDSCAT
Issue:	8
Issue Date:	01/07/17



www.hardyspicer.com.au

Document No:	HSDSCAT
Issue:	8
Issue Date:	01/07/17

MECHANICS TYPE 2C

E = 33.34
 1.31
 F = 59.44
 2.34
 C = 13.21
 0.52

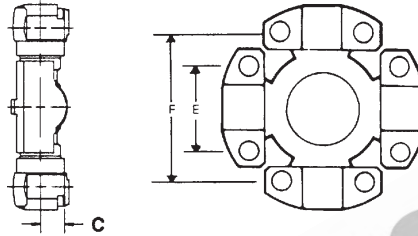

2C MECHANICS TYPE UNIVERSAL JOINT

S = STRAIGHT HOLE

T = THREADED HOLE

C = COUNTERSUNK HOLE

PART No.	LUBE	BEARING CAPS
114-2110	CAP	4 X WINGS (T)
RUJ-2046	CAP	4 X WINGS (S)
114-2116	SIDE	2 X WING (T) 2 X WING (C)
114-2117	SIDE	4 X WING (C)

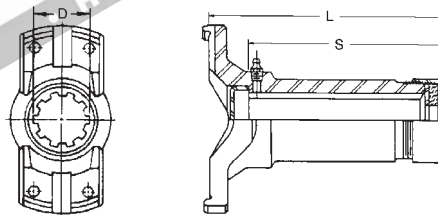

2C SLIP YOKE

PART No.	SPLINE O.D. & No.	MTG. FACE TO END OF SPLINE	LENGTH OF SPLINE	BOLT HOLES	JOINT ANGLE	DUST CAP	COMMENTS
	D	L	S				
2C-3-2760#	30.15-16 1.188	112.78 4.440	102.87 4.050	S	20	DCK2CA	STANDARD

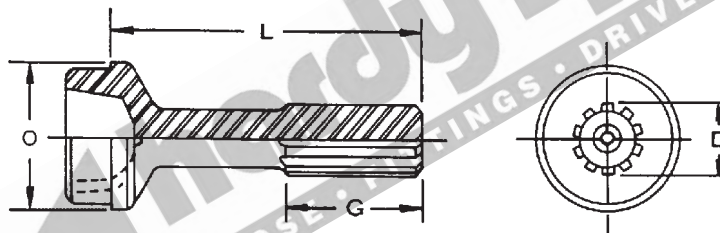

2C STUB

SPLINE TYPE:				BUTT TYPE:				COMMENTS
HC = HARDY COATED ST = STEEL				H = HOLLOW S = SOLID				
PART No.	SPLINE DIA. & No.	SPLINE TYPE	LENGTH OF SPLINE	END OF SPLINE TO POINT OF WELD	BUTT TYPE	TUBE O.D. & THICKNESS	TUBE PART No.	
	D		G	L		O		
2C-42-5721#	30.16-16 1.188	ST	54.10 2.130	134.11 5.280	S	50.80 x 1.65 2.00 x 0.065	1616-0000	STANDARD

INDENT ITEM

www.hardyspicer.com.au

Document No:	HSDSCAT
Issue:	8
Issue Date:	01/07/17

2C MECHANICS TYPE

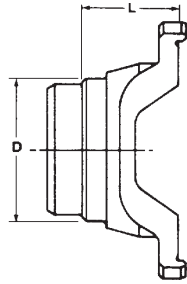

2C WELD YOKE

BOLT HOLES:		S=STRAIGHT T=THREAD	BUTT TYPE:		H=HOLLOW S=SOLID	COMMENTS	
PART No.	MTG. FACE TO POINT OF WELD L	TUBE O.D. & WALL THICKNESS D	TUBE PART No.	BUTT TYPE	BOLT HOLES	MAX. ANGLE	
2C-26-339#	25.40 1.000	50.80 x 1.65 2.000 x 0.065	1616-0000	H	S	20	STANDARD

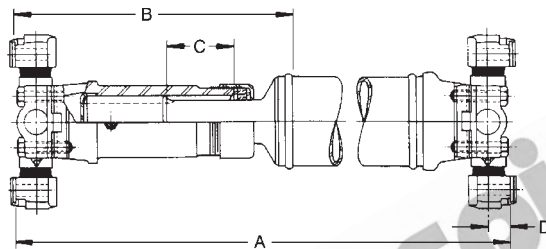

2C TUBULAR TYPE ASSEMBLY CHART

MINIMUM TUBE LENGTH = 25.4mm (1.00")										
BOLT HOLES		S=STRAIGHT T=THREADED	C/L TO MTG. FACE			D=13.21mm				
SLIP YOKE FEMALE PART No.	SLIP YOKE BOLT HOLES	STUB MALE PART No.	MTG. FACE TO POINT OF WELD CLOSED B	TOTAL SLIP C	CLOSED LENGTH MTG. FACE TO MTG. FACE WITH UJ's A	WELD YOKE PART No.	WELD YOKE BOLT HOLES	MAX ANGLE OF ASSY.	TUBE PART No. & SIZE	
2C-3-2760	S	2C-42-5721	161.02 6.340	49.30 1.940	239.27 9.420	2C-26-339	S	20	1610-0000 2.000 x 0.065	

www.hardyspicer.com.au

Document No:	HSDSCAT
Issue:	8
Issue Date:	01/07/17

INDENT ITEM

MECHANICS TYPE 2C

BOLT HOLES:
S = STRAIGHT
T = THREADED

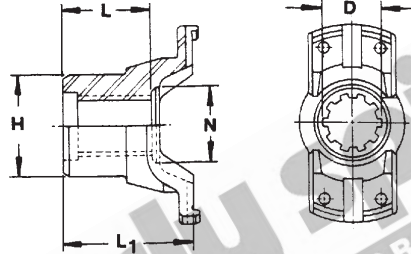

2C END YOKE

END YOKE PART No.	SPLINE DIA. & No.	LENGTH OF HOLE	HUB O.D.	NUT SEAT	MTG. FACE TO END OF SPLINE	BOLT HOLES	JOINT ANGLE	COMMENTS
	D	L	H	N				
2C-4-3111#	24.99-11	26.99	47.63	36.51	50.40	C	S	
INVOLUTE SPLINE	0.984	1.062	1.875	1.437	1.984			
2C-4-4053#	25.40	19.05		39.67	71.42	C	S	
PILOT BORED	1.000	0.750		1.562	2.811			

BOLT HOLES:
S = STRAIGHT
T = THREADED

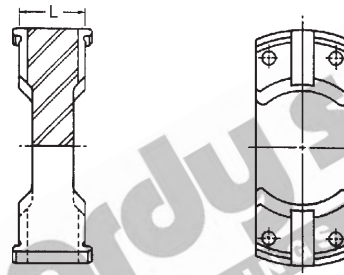

2C CENTRE PLATE

PART No.	MTG. FACE TO MTG. FACE	BOLT HOLE	COMMENTS
	L		
2C-29-485#	20.57 0.810	S	USE 114-2116 + 114-2110 UJ's

www.hardyspicer.com.au

Document No:	HSDSCAT
Issue:	8
Issue Date:	01/07/17

This catalogue is the copyright of Hardy Spicer

2C MECHANICS TYPE



www.hardyspicer.com.au

Document No:	HSDSCAT
Issue:	8
Issue Date:	01/07/17

MECHANICS TYPE 3C

E = 36.52
 1.43
 F = 69.85
 2.74
 C = 15.50
 0.61

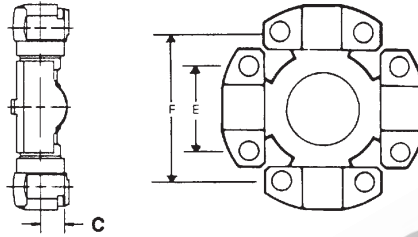

3C MECHANICS TYPE UNIVERSAL JOINT

S = STRAIGHT HOLE		T = THREADED HOLE	C = COUNTERSUNK HOLE
PART No.	LUBE	BEARING CAPS	
114-3100	SIDE	4 X WING (T)	
114-3101	SIDE	2 X WING (T) 2 X WING (C)	
114-3103	SIDE	4 X WING (C)	
114-3125	SIDE	4 X BB2 BLOCK (S)	
114-3120	SIDE	2 X R1 ROUND 2 X BB2 BLOCK - (3R TO 3C)	

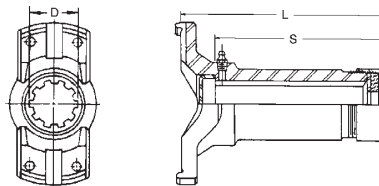

3C SLIP YOKE

PART No.	SPLINE O.D. & No.	MTG. FACE TO END OF SPLINE	LENGTH OF SPLINE	BOLT HOLES	JOINT ANGLE	DUST CAP	COMMENTS
	D	L	S				
3C-3-2770	31.75-16 1.250	108.71 4.280	103.19 4.060	S	20	DCK3CA	STANDARD
3C-3-2850#	31.75-16 1.250	66.68 2.625	65.09 2.560	S	20	DCK3CA	SHORT COUPLED

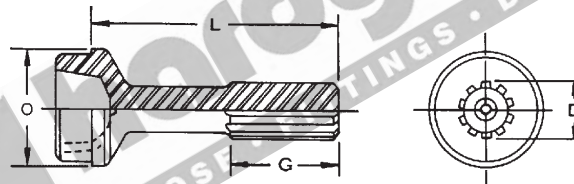

3C STUB

SPLINE TYPE:		HC = HARDY COATED ST = STEEL			BUTT TYPE:		H = HOLLOW S = SOLID		COMMENTS
PART No.	SPLINE DIA. & No.	SPLINE TYPE	LENGTH OF SPLINE	END OF SPLINE TO POINT OF WELD	BUTT TYPE	TUBE O.D. & THICKNESS	TUBE PART No.		
	D		G	L		O			
3C-42-5731	31.75-16 1.250	ST	58.67 2.310	139.70 5.500	S	63.50 x 2.11 2.500 x 0.083		STANDARD	

INDENT ITEM

www.hardyspicer.com.au

Document No:	HSDSCAT
Issue:	8
Issue Date:	01/07/17

This catalogue is the copyright of Hardy Spicer

3C MECHANICS TYPE

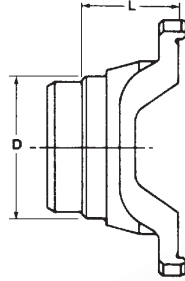

3C WELD YOKE

BOLT HOLES:		S=STRAIGHT T=THREAD		BUTT TYPE:		H=HOLLOW S=SOLID		COMMENTS
PART No.	MTG. FACE TO POINT OF WELD L	TUBE O.D. & WALL THICKNESS D	TUBE PART No.	BUTT TYPE	BOLT HOLES	MAX. ANGLE		
3C-26-340	28.44 1.120	63.50 x 2.10 2.500 x 0.083		H	S	20	STANDARD	

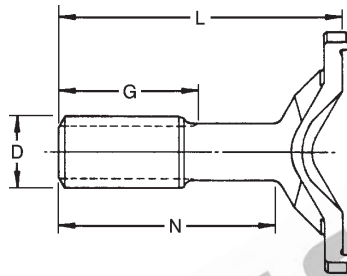

3C STUB YOKE

SPLINE TYPE:				HC = HARDY COATED ST = STEEL		BUTT TYPE:		H = HOLLOW S = SOLID		COMMENTS
PART No.	SPLINE DIA. & No. D	LENGTH OF SPLINE G	MTG. FACE TO END OF SPLINE L	SHOULDER TO END OF SPLINE N	BOLT HOLES	SPLINE TYPE O	MAX. ANGLE			
3C-82-8601#	31.75-16 1.250	44.45 1.750	103.12 4.060	79.25 3.120	S	ST	20	STANDARD		

INDENT ITEM

www.hardyspicer.com.au

Document No:	HSDSCAT
Issue:	8
Issue Date:	01/07/17

MECHANICS TYPE 3C

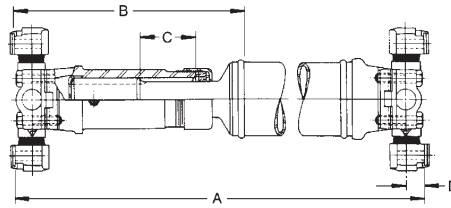

3C TUBULAR TYPE ASSEMBLY CHART

MINIMUM TUBE LENGTH = 35.0mm (1.375")										
BOLT HOLES					S=STRAIGHT		C/L TO MTG. FACE			D=15.50mm
					T=THREADED					
SLIP YOKE FEMALE PART No.	SLIP YOKE BOLT HOLES	STUB MALE PART No.	MTG. FACE TO POINT OF WELD CLOSED	TOTAL SLIP	CLOSED LENGTH MTG. FACE TO MTG. FACE WITH UJ's	WELD YOKE PART No.	WELD YOKE BOLT HOLES	MAX ANGLE OF ASSY.	TUBE PART No. & SIZE	
			B	C	A					
3C-3-2770	S	3C-42-5731	175.50 6.910	44.50 1.750	264.50 10.41	3C-26-340	S	20	2.000 x 0.083	

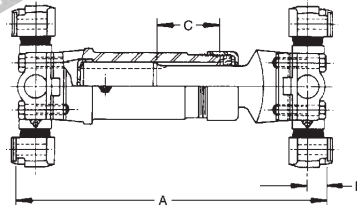

3C SHORT COUPLED ASSEMBLY CHART

SLIP YOKE FEMALE PART No.	SLIP YOKE BOLT HOLES	STUB YOKE MALE PART No.	BOLT HOLES S=STRAIGHT T=THREADED	SPLINE SIZE & No.	TOTAL SLIP	CLOSED LENGTH MTG. FACE TO MTG. FACE (INCL. UJ's)	MAX. ANGLE OF ASSY.	C/L TO MTG. FACE UJ's
					C	A		B
3C-3-2850#	S	3C-82-8601#	S	31.75-16 1.250	19.10 0.750	168.20 6.620	20	15.50 0.610

BOLT HOLES:
S = STRAIGHT
T = THREADED

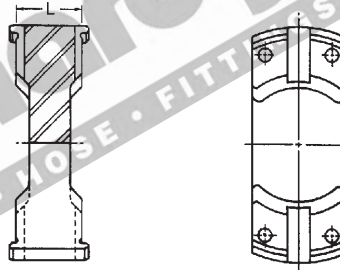

3C CENTRE PLATE

PART No.	MTG. FACE TO MTG. FACE L	BOLT HOLE	COMMENTS
3C-29-507#	23.88 0.940	S	USE 114-3101 + 114-3100 UJ's

INDENT ITEM

www.hardyspicer.com.au

Document No:	HSDSCAT
Issue:	8
Issue Date:	01/07/17

This catalogue is the copyright of Hardy Spicer

3C MECHANICS TYPE



www.hardyspicer.com.au

Document No:	HSDSCAT
Issue:	8
Issue Date:	01/07/17

MECHANICS TYPE 4C

E = 36.52
1.43
F = 87.32
3.43
C = 15.50
0.61

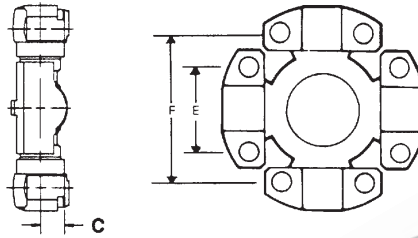

4C MECHANICS TYPE UNIVERSAL JOINT

S = STRAIGHT HOLE		T = THREADED HOLE	C = COUNTERSUNK HOLE
PART No.	LUBE	BEARING CAPS	
RUJ-4003	SIDE	2 X WING (T) 2 X WING (C)	
114-4105	SIDE	2 X WING (S) 2 X WING (C)	
114-4110	SIDE	2 X BLOCK (S) 2 X WING (T)	
114-4113	SIDE	4 X BLOCK (S)	
114-4100	SIDE	4 X WING (T)	
114-4103	SIDE	2 X WING (S) 2 X WING (T)	

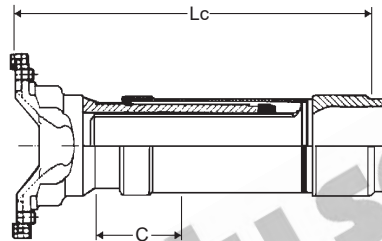

4C SLIP ASSEMBLY

S=STRAIGHT BOLT HOLES				T=THREADED BOLT HOLES			COMMENTS
PART No.	SPLINE O.D. & No.	MTG. FACE TO WELD POINT Lc	TOTAL SLIP C	TUBE O.D. & WALL THICKNESS	BOLT HOLES	JOINT ANGLE	
4C-84-181	40.00-24 1.575	215.00 8.465	60.00 2.362	63.50 x 2.41 2.500 x .095	T		
Slip Yoke & Stub Shaft not sold separately.							

www.hardyspicer.com.au

Document No:	HSDSCAT
Issue:	8
Issue Date:	01/07/17

This catalogue is the copyright of Hardy Spicer

4C MECHANICS TYPE

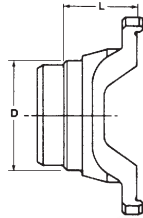

4C WELD YOKE

BOLT HOLES:		S=STRAIGHT T=THREAD	BUTT TYPE:		H=HOLLOW S=SOLID		
PART No.	MTG. FACE TO POINT OF WELD L	TUBE O.D. & WALL THICKNESS D	TUBE PART No.	BUTT TYPE	BOLT HOLES	MAX. ANGLE	COMMENTS
4C-26-341	31.75 1.250	63.50 x 2.10 2.500 x 0.083		H	T	25	

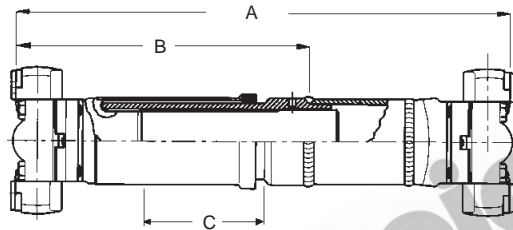

4C TUBULAR TYPE ASSEMBLY CHART

MINIMUM TUBE LENGTH = 40.0mm (1.57")								
BOLT HOLES		S=STRAIGHT T=THREADED	C/L TO MTG. FACE			D=15.50mm		
SLIP ASSEMBLY PART No.	SLIP YOKE BOLT HOLES	MTG. FACE TO POINT OF WELD CLOSED B	TOTAL SLIP C	CLOSED LENGTH MTG. FACE TO MTG. FACE WITH UJ's A	WELD YOKE PART No.	WELD YOKE BOLT HOLES	MAX ANGLE OF ASSY.	TUBE PART No. & SIZE
4C-84-181	T	246.00 9.685	60.00 2.362	339.72 13.375	4C-26-341	T	25	2013-0000 2.500 x 0.095

www.hardyspicer.com.au

Document No:	HSDSCAT
Issue:	8
Issue Date:	01/07/17

MECHANICS TYPE 4C

BOLT HOLES:
 S = STRAIGHT
 T = THREADED

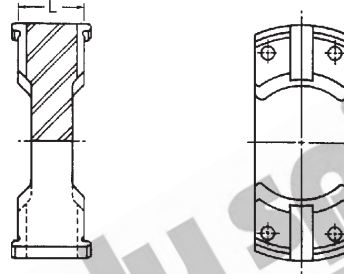

4C CENTRE PLATE

PART No.	MTG. FACE TO MTG. FACE L	BOLT HOLE	COMMENTS
4C-29-4863#	23.88 0.940	S	USE 114-4103 + 114-4100 UJ's

www.hardyspicer.com.au

Document No:	HSDSCAT
Issue:	8
Issue Date:	01/07/17

This catalogue is the copyright of Hardy Spicer

4C MECHANICS TYPE



www.hardyspicer.com.au

Document No:	HSDSCAT
Issue:	8
Issue Date:	01/07/17

MECHANICS TYPE 5C

E = 42.85
 1.68
 F = 88.90
 3.49
 C = 17.53
 0.69

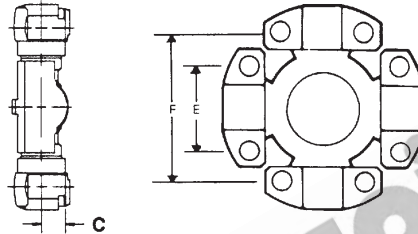

5C MECHANICS TYPE UNIVERSAL JOINT

S = STRAIGHT HOLE		T = THREADED HOLE	C = COUNTERSUNK HOLE
PART No.	LUBE	BEARING CAPS	
114-5122	SIDE	4 X WING (T)	
114-5148	SIDE	4 X WING (S)	
114-5177	SIDE	4 X BLOCK (S)	
114-5127	SIDE	2 X WING (S) 2 X WING (T)	
114-5173	SIDE	2 X BLOCK (S) 2 X WING (T)	
114-5031	NIL	HOLE IN CROSS 2 X WING (T) 2 X BLOCK (S)	
114-5177PL	NIL	PREMIUM PERMANENT LUBE	

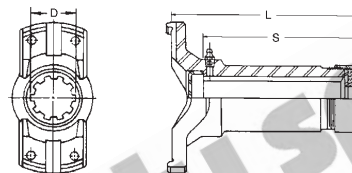

5C SLIP YOKE

PART No.	SPLINE O.D. & No.	MTG. FACE TO END OF SPLINE	LENGTH OF SPLINE	BOLT HOLES	JOINT ANGLE	DUST CAP	COMMENTS
	D	L	S				
5C-3-2790	39.62-16 1.560	142.88 5.625	127.00 5.000	T	20	DCK5CA	STANDARD
5C-3-2870	39.62-16 1.560	111.13 4.375	95.25 3.750	T	20	DCK5CA	SHORT COUPLED

www.hardyspicer.com.au

Document No:	HSDSCAT
Issue:	8
Issue Date:	01/07/17

This catalogue is the copyright of Hardy Spicer

5C MECHANICS TYPE

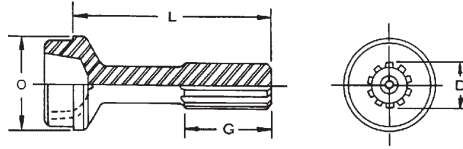

5C STUB

SPLINE TYPE:		HC = HARDY COATED ST = STEEL			BUTT TYPE:		H = HOLLOW S = SOLID		COMMENTS
PART No.	SPLINE DIA. & No.	SPLINE TYPE	LENGTH OF SPLINE	END OF SPLINE TO POINT OF WELD	BUTT TYPE	TUBE O.D. & THICKNESS	TUBE PART No.		
	D		G	L		O			
5C-42-5761	39.62-16 1.560	ST	76.20 3.000	161.79 6.370	S	63.50 x 2.76 2.500 x 0.109		STANDARD	
Hardy Spicer 1480 Stubs may be used as an alternative									

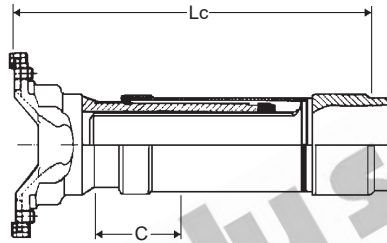

5C SLIP ASSEMBLY

PART No.	SPLINE O.D. & No.	S=STRAIGHT BOLT HOLES			T=THREADED BOLT HOLES		COMMENTS
		MTG. FACE TO WELD POINT	TOTAL SLIP	TUBE O.D. & WALL THICKNESS	BOLT HOLES	JOINT ANGLE	
		Lc	C				
5C-84-171	40.00-24 1.575	220.00 8.661	60.00 2.362	63.50 x 2.41 2.500 x .095	T		Yoke Shaft & Sleeve not sold separately.

www.hardyspicer.com.au

Document No:	HSDSCAT
Issue:	8
Issue Date:	01/07/17

MECHANICS TYPE 5C

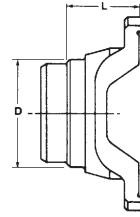

5C WELD YOKE

BOLT HOLES:		S=STRAIGHT T=THREAD		BUTT TYPE:		H=HOLLOW S=SOLID		COMMENTS
PART No.	MTG. FACE TO POINT OF WELD L	TUBE O.D. & WALL THICKNESS D	TUBE PART No.	BUTT TYPE	BOLT HOLES	MAX. ANGLE		
5C-26-235	28.44 1.120	63.50 x 2.41 2.500 x 0.095	2013-0000	H	S	15		
5C-26-347	28.44 1.120	63.50 x 2.76 2.500 x 0.109		H	T	15	STANDARD	
5C-28-502	39.00 1.535	73.00 x 4.00 2.874 x 0.157	73X4MM		T			

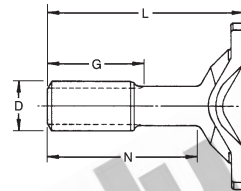

5C STUB YOKE

SPLINE TYPE:				BUTT TYPE:		H = HOLLOW S = SOLID		COMMENTS
PART No.	SPLINE DIA. & No.	LENGTH OF SPLINE	MTG. FACE TO END OF SPLINE	SHOULDER TO END OF SPLINE	BOLT HOLES	SPLINE TYPE	MAX. ANGLE	
	D	G	L	N		O		
5C-82-8621	39.62-16 1.560	57.15 2.250	134.95 5.313	102.39 4.031	T	ST	15	

www.hardyspicer.com.au

Document No:	HSDSCAT
Issue:	8
Issue Date:	01/07/17

This catalogue is the copyright of Hardy Spicer

5C MECHANICS TYPE

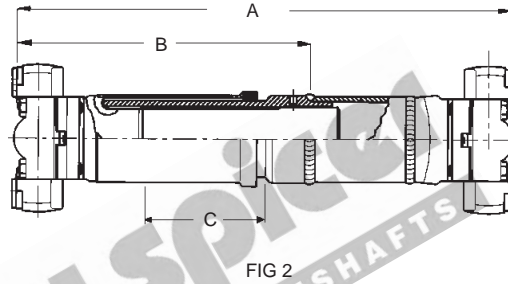
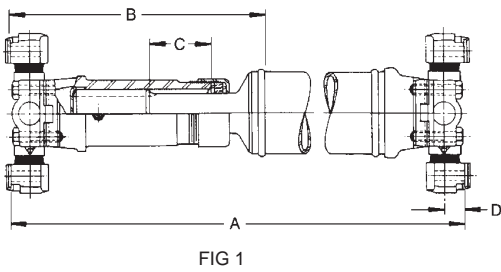

5C TUBULAR TYPE ASSEMBLY CHART

MINIMUM TUBE LENGTH = 45.0mm (1.77")										
BOLT HOLES		S=STRAIGHT T=THREADED			C/L TO MTG. FACE					D=17.53mm
SLIP YOKE FEMALE PART No.	SLIP YOKE BOLT HOLES	STUB MALE PART No.	U/J FACE TO POINT OF WELD CLOSED	TOTAL SLIP	CLOSED LENGTH MTG. FACE TO MTG. FACE WITH UJ's	WELD YOKE PART No.	WELD YOKE BOLT HOLES	MAX ANGLE OF ASSY.	TUBE PART No. & SIZE	
			B	C	A					
5C-3-2790 (FIG 1)	S	5C-42-5761	212.73 8.380	50.80 2.000	321.23 12.650	5C-26-347	S	15	2.500 x 0.083	
SLIP / STUB ASSEMBLY PART No.			B	C	A					
5C-84-171 Sleeve type (FIG 2)			255.00 10.039	60.00 2.362	363.50 14.311	5C-26-235	S	15	2013-0000 2.500 x 0.095	

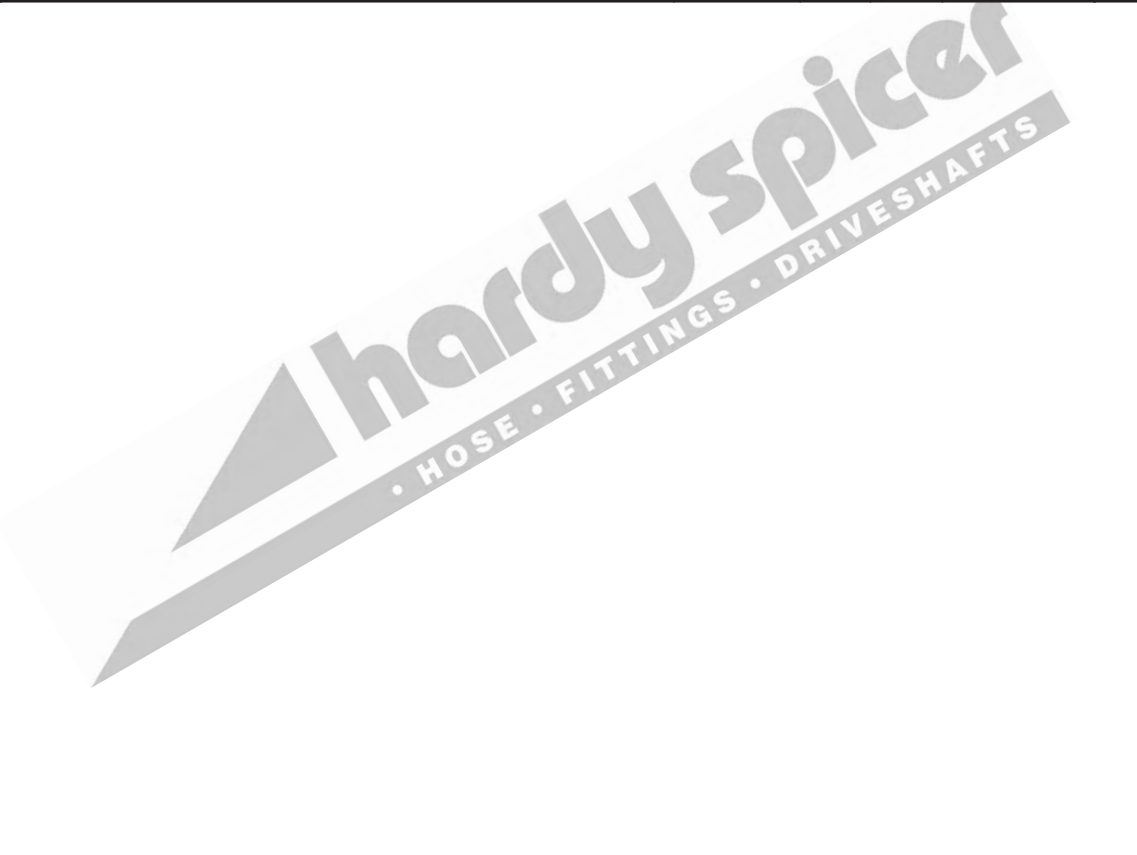

www.hardyspicer.com.au

Document No:	HSDSCAT
Issue:	8
Issue Date:	01/07/17

MECHANICS TYPE 5C

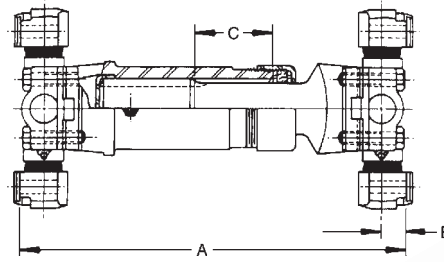

5C SHORT COUPLED ASSEMBLY CHART

SLIP YOKE FEMALE PART No.	SLIP YOKE BOLT HOLES	STUB YOKE MALE PART No.	BOLT HOLES S=STRAIGHT T=THREADED	SPLINE SIZE & No.	TOTAL SLIP	CLOSED LENGTH MTG. FACE TO MTG. FACE (INCL. UJ's)	MAX. ANGLE OF ASSY.	C/L TO MTG. FACE UJ's
					C	A		B
5C-3-2870	T	5C-82-8621	T	39.62-16 1.560	38.10 1.500	214.60 8.449	15	17.53 0.690

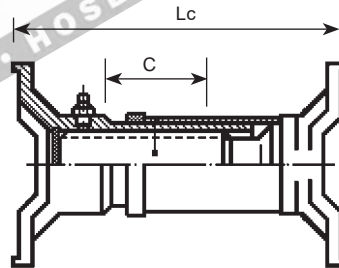

5C SHORT COUPLED SLIP ASSEMBLY

S=STRAIGHT BOLT HOLES				T=THREADED BOLT HOLES			
PART No.	SPLINE O.D. & No.	MTG. FACE TO MTG. FACE CLOSED	TOTAL SLIP	C/L TO MTG. FACE OF UJ's	BOLT HOLES	JOINT ANGLE	COMMENTS
		Lc	C				
5C-83-220	40.00-24 1.575	220.00 8.661	60.00 2.362		T		COVER TUBE TYPE

Yoke Shaft & Slip not sold separately.

BOLT HOLES:
S = STRAIGHT
T = THREADED

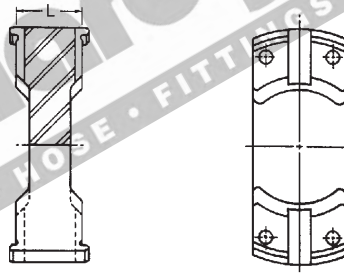

5C CENTRE PLATE

PART No.	MTG. FACE TO MTG. FACE	BOLT HOLE	COMMENTS
	L		
5C-29-4871#	35.05 1.380	S	USE 114-5127 + 114-5122 UJ's

INDENT ITEM

www.hardyspicer.com.au

Document No:	HSDSCAT
Issue:	8
Issue Date:	01/07/17

5C MECHANICS TYPE



www.hardyspicer.com.au

Document No:	HSDSCAT
Issue:	8
Issue Date:	01/07/17

MECHANICS TYPE 6C

E = 42.85
 1.68
 F = 114.30
 4.49
 C = 17.53
 0.69

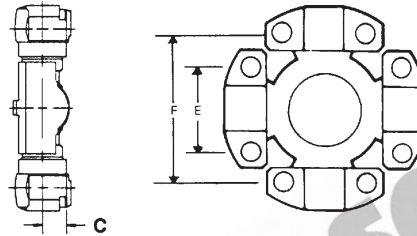

6C MECHANICS TYPE UNIVERSAL JOINT

PART No.	LUBE	S = STRAIGHT HOLE		T = THREADED HOLE		C = COUNTERSUNK HOLE	
		BEARING CAPS					
114-6104	SIDE	4 X WING (C)					
114-6128	SIDE	4 X BLOCK (S)					
114-6143	SIDE	4 X WING (T)					
114-6143R	SIDE	PREMIUM 4 X WING (T)					
114-6103	SIDE	2 X WING (S)	2 X WING (T)				
114-6114	SIDE	2 X BLOCK (S)	2 X WING (T)				
114-6114R	SIDE	PREMIUM 2 X BLOCK (S) 2 X WING (T)					
114-6152	SIDE	2 X WING (S)	2 X WING (T)				
114-6162	SIDE	4 X WING (T) - 6C X 7C SERIES					
114-6163	SIDE	2 X WING (T) - 6C SERIES, 2 X BLOCK (S) - 7C SERIES					
114-6285	SIDE	2 X BLOCK (S) 2 X DOUBLE SIDED BLOCK (FOR DOUBLE CARDAN JOINT)					
114-6128PL	NIL	PREMIUM PERMANENT LUBE					
114-6128R	SIDE	PREMIUM					
114-6150	SIDE	2 X ROUND (33.35mm R1), 2 X BLOCK (S)					
114-6150	SIDE	2 X ROUND (34mm R1), 2 X BLOCK (S)					

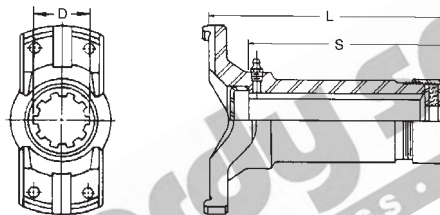

6C SLIP YOKE

PART No.	SPLINE O.D. & No.		MTG. FACE TO END OF SPLINE		LENGTH OF SPLINE	BOLT HOLES	JOINT ANGLE	DUST CAP	COMMENTS
	D	L	L	S					
6C-3-2540	44.45-16 1.750	155.58 6.125	133.35 5.250	T			DCK6CA	STANDARD	
6C-3-2800	44.45-16 1.750	187.45 7.380	161.93 6.370	T	30		DCK6CA	STANDARD MEDIUM	
6C-3-2880	44.45-16 1.750	101.60 4.000	84.07 3.310	T	30		DCK6CA	SHORT COUPLED USE WITH 6C-82-8631	
6C-3-3190	44.45-16 1.750	241.30 9.500	202.95 7.990	S			DCK6CA	STANDARD LONG	
6C-3-0137	50.80-16 2.000	137.00 5.394		T				SHORT COUPLED USE WITH 6C-82-602	

www.hardyspicer.com.au

Document No:	HSDSCAT
Issue:	8
Issue Date:	01/07/17

This catalogue is the copyright of Hardy Spicer

6C MECHANICS TYPE

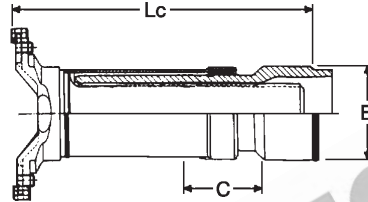

6C SLIP ASSEMBLY

S=STRAIGHT BOLT HOLES				T=THREADED BOLT HOLES			
PART No.	SPLINE O.D. & No.	MTG. FACE TO WELD POINT Lc	TOTAL SLIP C	TUBE O.D. & WALL THICKNESS	BOLT HOLES	JOINT ANGLE	COMMENTS
6C-83-100	52.00-24 2.047	238.00 9.370	105.00 4.134	70.00 x 4.00 2.756 x .157	T		

Yoke Shaft & Sleeve not sold separately.

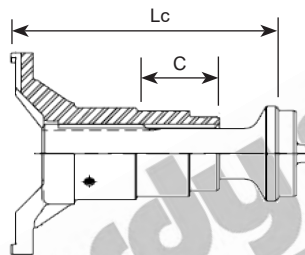

6C SLIP/STUB ASSEMBLY

S=STRAIGHT BOLT HOLES				T=THREADED BOLT HOLES			
PART No.	SPLINE O.D. & No.	MTG. FACE TO WELD POINT Lc	TOTAL SLIP C	TUBE O.D. & WALL THICKNESS	BOLT HOLES	JOINT ANGLE	COMMENTS
6C-84-248	50.80-16 2.000	250.00 9.843	105.00 4.134	76.20 x 2.41 3.000 x .095	T		COATED STUB

Slip & Stub sold as assembly

www.hardyspicer.com.au

Document No:	HSDSCAT
Issue:	8
Issue Date:	01/07/17

MECHANICS TYPE 6C

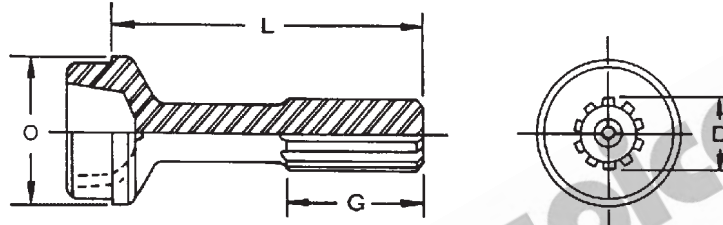

6C STUB

SPLINE TYPE:		HC = HARDY COATED ST = STEEL			BUTT TYPE:		H = HOLLOW S = SOLID	
PART No.	SPLINE DIA. & No. D	SPLINE TYPE	LENGTH OF SPLINE G	END OF SPLINE TO POINT OF WELD L	BUTT TYPE	TUBE O.D. & THICKNESS O	TUBE PART No.	COMMENTS
6C-42-5581	44.45-16 1.750	ST	76.20 3.000	177.80 7.000	S	76.20 x 2.41 3.000 x 0.095	2413-0000	STANDARD
6C-42-5791	44.45-16 1.750	ST	76.20 3.000	247.70 9.752	S	76.20 x 2.41 3.000 x 0.095	2413-0000	LONG

Hardy Spicer 1510, 1550 Stubs may be used as an alternative

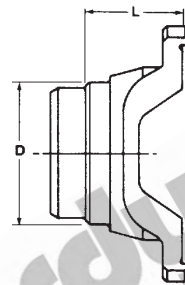

6C WELD YOKE

BOLT HOLES:		S=STRAIGHT T=THREAD		BUTT TYPE:		H=HOLLOW S=SOLID	
PART No.	MTG. FACE TO POINT OF WELD L	TUBE O.D. & WALL THICKNESS D	TUBE PART No.	BUTT TYPE	BOLT HOLES	MAX. ANGLE	COMMENTS
6C-28-600	47.50 1.870	76.20 x 2.41 3.000 x 0.095	2413-0000	S	T	30	STANDARD WITH THREADED BOLT HOLES
6C-26-704	48.00 1.890	70.00 x 4.00 2.756 x 0.157	70X4MM	H	T	25	

www.hardyspicer.com.au

Document No:	HSDSCAT
Issue:	8
Issue Date:	01/07/17

6C MECHANICS TYPE

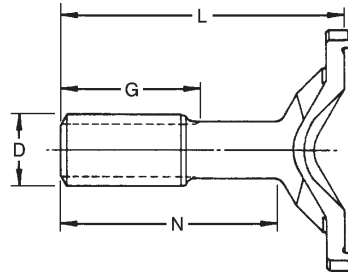

6C STUB YOKE

SPLINE TYPE:		HC = HARDY COATED ST = STEEL			BUTT TYPE:		H = HOLLOW S = SOLID		COMMENTS
PART No.	SPLINE DIA. & No.	LENGTH OF SPLINE	MTG. FACE TO END OF SPLINE	SHOULDER TO END OF SPLINE	BOLT HOLES	SPLINE TYPE	MAX. ANGLE		
	D	G	L	N		O			
6C-82-8241	44.45-10 1.750	63.50 2.500	141.27 5.560	100.10 3.940	S	ST	30		
6C-82-8631	44.45-16 1.750	50.80 2.000	133.35 5.250	93.00 3.661	T	ST	30		

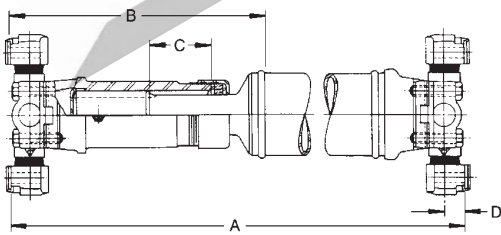

FIG 1

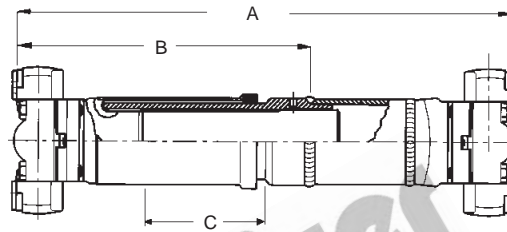

FIG 2

6C TUBULAR TYPE ASSEMBLY CHART

MINIMUM TUBE LENGTH = 60.0mm (2.36")									
BOLT HOLES		S=STRAIGHT T=THREADED			C/L TO MTG. FACE D=17.53mm				
SLIP YOKE FEMALE PART No.	SLIP YOKE BOLT HOLES	STUB MALE PART No.	U/J FACE TO POINT OF WELD CLOSED	TOTAL SLIP	CLOSED LENGTH MTG. FACE TO MTG. FACE WITH UJ's	WELD YOKE PART No.	WELD YOKE BOLT HOLES	MAX ANGLE OF ASSY.	TUBE PART No. & SIZE
			B	C	A				
6C-3-2540 (FIG 1)	S	6C-42-5581	217.60 8.560	57.20 2.250	345.90 13.610	6C-26-324	S	30	2413-0000 3.000 x 0.095
SLIP / STUB ASSEMBLY PART No.			B	C	A				
6C-83-100 Sleeve type (FIG 2)			238.00 9.370	105.00 4.134	366.00 14.409	6C-26-704	T		70X4MM 70.00 x 4.00mm
6C-84-248 Slip/Stub type (FIG 1)			285.00 11.220	105.00 4.134	408.00 16.063	6C-28-600	T		2413-0000 3.000 x 0.095

www.hardyspicer.com.au

Document No:	HSDSCAT
Issue:	8
Issue Date:	01/07/17

MECHANICS TYPE 6C

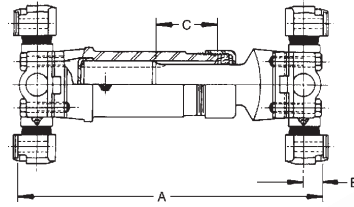

6C SHORT COUPLED ASSEMBLY CHART

SLIP YOKE FEMALE PART No.	SLIP YOKE BOLT HOLES	STUB YOKE MALE PART No.	BOLT HOLES S=STRAIGHT T=THREADED	SPLINE SIZE & No.	TOTAL SLIP C	CLOSED LENGTH MTG. FACE TO MTG. FACE (INCL. UJ's) A	MAX. ANGLE OF ASSY.	C/L TO MTG. FACE UJ's B
6C-3-2880	T	6C-82-8631	T	44.45-16 1.750	33.00 1.300	185.90 7.320	30	17.53 0.690

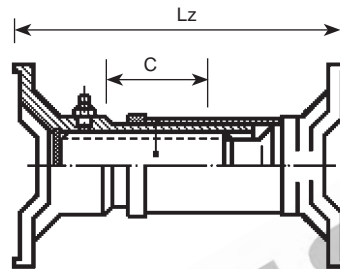

6C SHORT COUPLED SLIP ASSEMBLY

S=STRAIGHT BOLT HOLES				T=THREADED BOLT HOLES			COMMENTS
PART No.	SPLINE O.D. & No.	MTG. FACE TO MTG. FACE CLOSED Lz	TOTAL SLIP C	C/L TO MTG. FACE OF UJ's	BOLT HOLES	JOINT ANGLE	
6C-83-158	52.00-24 2.047	158.00 6.220	30.00 1.181		T		COVER TUBE TYPE
6C-83-190	50.00-24 1.969	190.00 7.480	45.00 1.772		T		COVER TUBE TYPE
6C-83-275	45.00-21 1.772	275.00 10.827	75.00 2.952		T		

Yoke Shaft & Slip not sold separately.

www.hardyspicer.com.au

Document No:	HSDSCAT
Issue:	8
Issue Date:	01/07/17

6C MECHANICS TYPE

BOLT HOLES:
S = STRAIGHT
T = THREADED

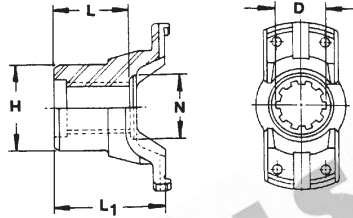

6C END YOKE

END YOKE PART No.	SPLINE DIA. & No. D	LENGTH OF HOLE L	HUB O.D. H	NUT SEAT N	MTG. FACE TO END OF SPLINE	BOLT HOLES	COMMENTS
6C-4-3491# INVOLUTE SPLINE	39.78-18 1.566	54.00 2.125	57.15 2.250	52.00 2.047	86.00 3.385	S	INDENT ONLY
6C-4-3681#	44.45-10 1.750	57.15 2.250	66.67 2.625	61.90 2.437	84.12 3.312	S	
6C-4-3871# INVOLUTE SPLINE	44.45-16 1.750	58.00 2.283	59.99 2.362	60.00 2.362	90.00 3.543	S	INDENT ONLY
6C-4-4093# PILOT BORED	25.40 1.000	73.00 2.875			95.00 3.740	S	INDENT ONLY

BOLT HOLES:
S = STRAIGHT
T = THREADED

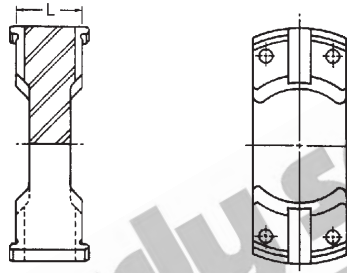

6C CENTRE PLATE

PART No.	MTG. FACE TO MTG. FACE L	BOLT HOLE	COMMENTS
6C-29-497#	35.05 1.380	S	USE 114-6152+ 114-6143 UJ's

www.hardyspicer.com.au

Document No:	HSDSCAT
Issue:	8
Issue Date:	01/07/17

INDENT ITEM

MECHANICS TYPE 6C

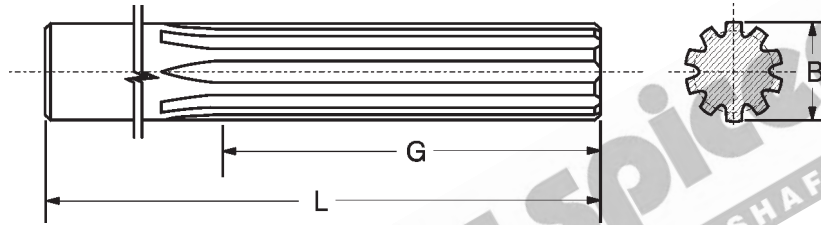

6C SPLINED BAR

PART No.	SPLINE O.D. & No. B	OVER ALL LENGTH L	SPLINE LENGTH G	COMMENTS
4-42-300	44.40-16 1.748	300.00 11.811	250.00 9.843	

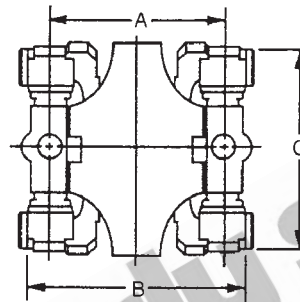

6CV DOUBLE CARDAN

PART No. COMPLETE ASSY.	OVERALL LENGTH L	C/LINE TO C/LINE J	UNIVERSAL JOINT TO SUIT	MAX ANGLE	COMMENTS
800-R6000	162.10 6.375	127.00 5.000	114-6285	43° EURO 40° USA	SEE NOTES BELOW

ALTERNATIVE : GWB 587.20 DOUBLE CARDAN PART No. 9-587-200500160

NOTES: 800-R6000 USA VERSION, PARTS NOT SOLD SEPERATELY
EURO VERSION, SEE 587-20 SERIES FOR BALL AND BOOT REPLACEMENTS

www.hardyspicer.com.au

Document No:	HSDSCAT
Issue:	8
Issue Date:	01/07/17

6C MECHANICS TYPE

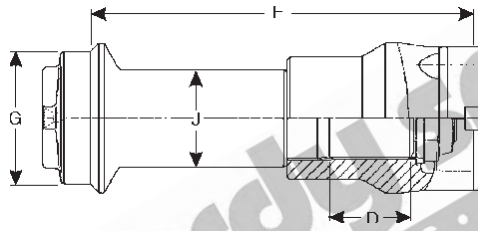

6C MIDSHIP ASSEMBLY

PART No.	SPLINE O.D. & No.	LENGTH OF SPLINE	WELD TO MOUNTING FACE	TUBE PART No. & SIZE	BEARING I.D.	COMMENTS
	C	D	F	G	J	
6C-56-6050	45.00-21	75.00	310.00 12.205	70.00 x 4.00 2.756 x 0.157	50.00 1.969	BEARING <i>KOM-30-6250</i> SUIT KOMATSU WA250 AND 270-3
6C-56-206-55	50.80-16	47.00	206.00 8.110	73.00 x 4.00 2.874 x 0.157	55.00 2.165	AVAILABLE WHILE STOCKS LAST

Document No:	HSDSCAT
Issue:	8
Issue Date:	01/07/17

MECHANICS TYPE 7C

E = 49.21
 1.93
 F = 117.60
 4.62
 C = 20.57
 0.81

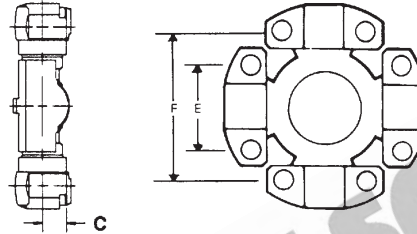

7C MECHANICS TYPE UNIVERSAL JOINT

S = STRAIGHT HOLE		T = THREADED HOLE	C = COUNTERSUNK HOLE
PART No.	LUBE	BEARING CAPS	
114-7126	SIDE	4 X BLOCK (S)	
114-7205	SIDE	4 X WING (T)	
114-7205R	SIDE	PREMIUM 4 X WING (T)	
114-7206	SIDE	2 X WING (C) 2 X WING (T)	
114-7207	SIDE	2 X BLOCK (S) 2 X WING (T)	
114-7207R	SIDE	PREMIUM 2 X BLOCK (S) 2 X WING (T)	
114-7126PL	NIL	PREMIUM PERMANENT LUBE, 4 X BLOCK (S)	
114-7126R	SIDE	PREMIUM, 4 X BLOCK (S)	

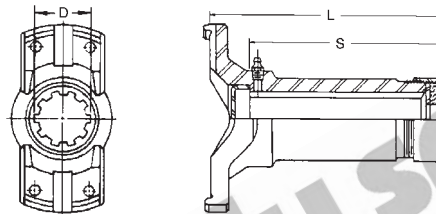

7C SLIP YOKE

PART No.	SPLINE O.D. & No.	MTG. FACE TO END OF SPLINE	LENGTH OF SPLINE	BOLT HOLES	JOINT ANGLE	DUST CAP	COMMENTS
	D	L	S				
7C-3-2550	50.80-16 2.000	180.98 7.125	165.10 6.500	T	25	DCK7CA	STANDARD
7C-3-2720	50.80-16 2.000	206.50 8.125	187.33 7.375	T	25	DCK7CA	MEDIUM
7C-3-2040	50.80-10 2.000	130.30 5.125	115.82 4.560	S	25	DCK7CA	SHORT COUPLED
7C-3-2890#	50.80-16 2.000	130.30 5.125	111.13 4.375	S	25	DCK7CA	SHORT COUPLED
7C-3-2590	50.80-16 2.000	276.35 10.880	228.60 9.000	T	25	DCK7CA	LONG

AVAILABLE WHILE STOCKS LAST

www.hardyspicer.com.au

Document No:	HSDSCAT
Issue:	8
Issue Date:	01/07/17

7C MECHANICS TYPE

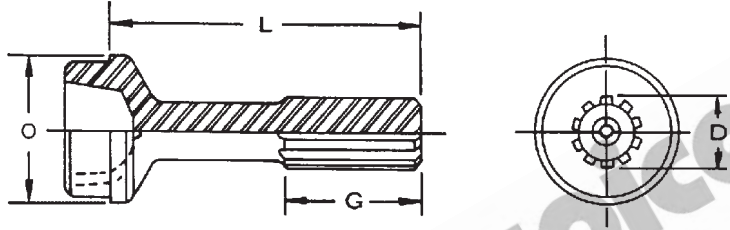

7C STUB

SPLINE TYPE:				HC = HARDY COATED ST = STEEL		BUTT TYPE:			H = HOLLOW S = SOLID	
PART No.	SPLINE DIA. & No. D	SPLINE TYPE	LENGTH OF SPLINE G	END OF SPLINE TO POINT OF WELD L	BUTT TYPE	TUBE O.D. & THICKNESS O	TUBE PART No.	COMMENTS		
7C-42-6061	50.80-16 2.000	ST	101.60 4.000	215.90 8.500	H	88.90 x 3.41 3.500 x 0.134	2810-0000	STANDARD 7C-3-2550		
7C-42-5681	50.80-16 2.000	ST	101.60 4.000	241.30 9.500	S	88.90 x 3.04 3.500 x 0.120		MEDIUM 7C-3-2720		
7C-42-6071	50.80-16 2.000	ST	99.06 3.900	271.50 10.689		88.90 x 3.41 3.500 x 0.134	2810-0000	LONG 7C-3-2590		
7C-42-6031*	50.80-16 2.000	ST	101.60 4.000	276.25 10.875		88.90 x 2.41 3.500 x 0.095	2813-0000	LONG 7C-3-2590		

Hardy Spicer 1610 Stubs may be used as an alternative
* Available while stocks last (superseded to 7C-42-6071)

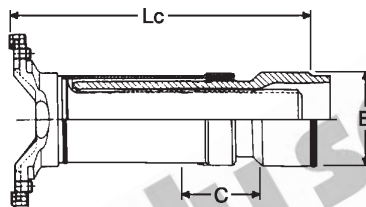

7C SLIP ASSEMBLY

S=STRAIGHT BOLT HOLES				T=THREADED BOLT HOLES			
PART No.	SPLINE O.D. & No.	MTG. FACE TO WELD POINT Lc	TOTAL SLIP C	TUBE O.D. & WALL THICKNESS	BOLT HOLES	JOINT ANGLE	COMMENTS
7C-83-105	55.00-20 2.165	243.00 9.567	130.00 5.118	88.00 x 4.00 3.464 x .157	T	25°	

Yoke Shaft & Sleeve not sold separately.
Replacement Dust Cover and Seal Assembly - 6-587-200900000

www.hardyspicer.com.au

Document No:	HSDSCAT
Issue:	8
Issue Date:	01/07/17

MECHANICS TYPE 7C

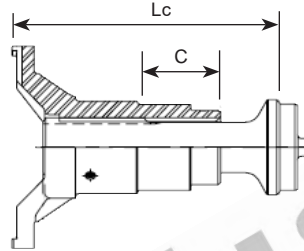

7C SLIP/STUB ASSEMBLY

S=STRAIGHT BOLT HOLES				T=THREADED BOLT HOLES			
PART No.	SPLINE O.D. & No.	MTG. FACE TO WELD POINT L_c	TOTAL SLIP C	TUBE O.D. & WALL THICKNESS	BOLT HOLES	JOINT ANGLE	COMMENTS
7C-84-246	50.80-16 2.000	258.00 10.157	63.50 2.500	88.90 x 3.41 3.500 x .134	T		COATED STUB
Slip & Stub sold as assembly							

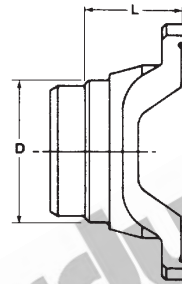

7C WELD YOKE

PART No.	S=STRAIGHT T=THREAD		TUBE PART No.	BUTT TYPE	BOLT HOLES	MAX. ANGLE	COMMENTS
	MTG. FACE TO POINT OF WELD L	TUBE O.D. & WALL THICKNESS D					
7C-26-393	50.00 1.969	88.00 x 4.00 3.465 x 0.157	88X4MM	H	T		TO SUIT 7C-83-105
7C-28-702	46.00 1.811	88.90 x 3.41 3.500 x 0.134	2810-0000	H	T	25	STANDARD
7CV-26-283#	63.50 2.500	88.90 x 3.04 3.500 x 0.120			S	40	FOR DOUBLE CARDAN JOINTS

www.hardyspicer.com.au

Document No:	HSDSCAT
Issue:	8
Issue Date:	01/07/17

INDENT ITEM

7C MECHANICS TYPE

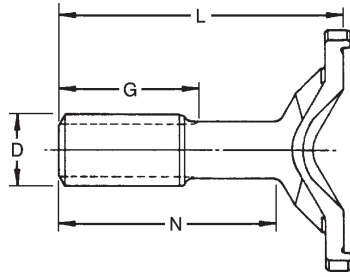

7C STUB YOKE

SPLINE TYPE:		HC = HARDY COATED ST = STEEL			BUTT TYPE:		H = HOLLOW S = SOLID		COMMENTS
PART No.	SPLINE DIA. & No.	LENGTH OF SPLINE	MTG. FACE TO END OF SPLINE	SHOULDER TO END OF SPLINE	BOLT HOLES	SPLINE TYPE	MAX. ANGLE		
	D	G	L	N		O			
7C-82-8251#	50.80-10 2.000	73.81 2.900	177.81 7.000	133.40 5.250	S	ST	25		
7C-82-8641#	50.80-16 2.000	69.85 2.750	175.26 6.900	133.35 5.250	T	ST	25		

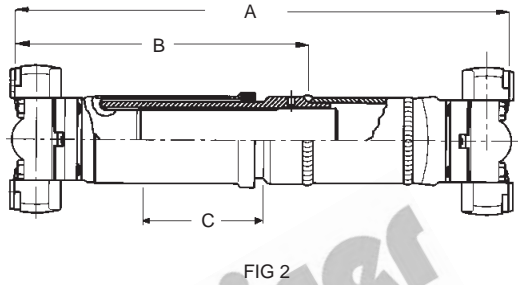
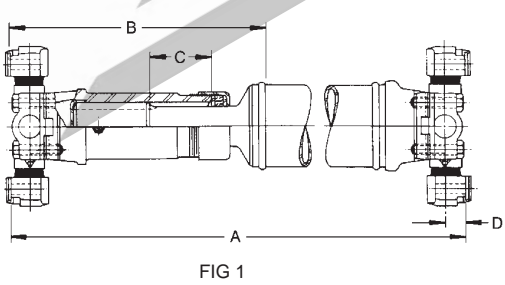

7C TUBULAR TYPE ASSEMBLY CHART

MINIMUM TUBE LENGTH = 60.0mm (2.36")									
BOLT HOLES		S=STRAIGHT T=THREADED			C/L TO MTG. FACE		D=20.57mm		
SLIP YOKE FEMALE PART No.	SLIP YOKE BOLT HOLES	STUB MALE PART No.	U/J FACE TO POINT OF WELD CLOSED	TOTAL SLIP	CLOSED LENGTH MTG. FACE TO MTG. FACE WITH UJ's	WELD YOKE PART No.	WELD YOKE BOLT HOLES	MAX ANGLE OF ASSY.	TUBE PART No. & SIZE
			B	C	A				
7C-3-2550 (FIG 1)	T	7C-42-6061	252.40 9.940	63.50 2.500	387.00 15.240	7C-28-702	T	25	2810-0000 3.500 x 0.134
7C-3-2720 (FIG 1)	T	7C-42-5681	281.00 11.060	88.90 3.500	415.70 16.370	7C-28-702	T	25	2810-0000 3.500 x 0.120
7C-3-2590 (FIG 1)	T	7C-42-6071	311.30 12.256	127.00 5.000	446.00 17.559	7C-28-702	T	25	2810-0000 3.500 x 0.134
SLIP / STUB ASSEMBLY PART No.			B	C	A				
7C-83-105 Sleeve type (FIG 2)			243.00 9.567	130.00 5.118	450.00 17.716	7C-26-393	T		88X4MM 88.00 x 4.00mm
7C-84-246 Slip/Stub type (FIG 1)			299.00 11.772	106.00 4.173	436.00 17.165	7C-28-702	T		2810-0000 3.500 x 0.134

www.hardyspicer.com.au

Document No:	HSDSCAT
Issue:	8
Issue Date:	01/07/17

INDENT ITEM

MECHANICS TYPE 7C

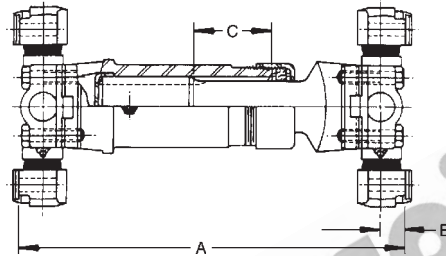

7C SHORT COUPLED ASSEMBLY CHART

SLIP YOKE FEMALE PART No.	SLIP YOKE BOLT HOLES	STUB YOKE MALE PART No.	BOLT HOLES S=STRAIGHT T=THREADED	SPLINE SIZE & No.	TOTAL SLIP C	CLOSED LENGTH MTG. FACE TO MTG. FACE (INCL. UJ's) A	MAX. ANGLE OF ASSY.	C/L TO MTG. FACE UJ's B
7C-3-2040	S	7C-82-8251	S	50.80-10 2.000	76.20 3.000	276.40 10.880	25	20.57 0.810
7C-3-2890	T	7C-82-8641	T	50.80-16 2.000	60.00 2.500	273.60 10.772	25	20.57 0.810

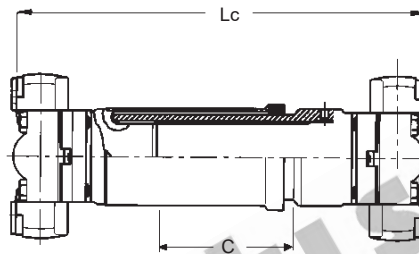

7C SHORT COUPLED ASSEMBLY

S=STRAIGHT BOLT HOLES				T=THREADED BOLT HOLES			
PART No.	SPLINE O.D. & No.	MTG. FACE TO MTG. FACE CLOSED Lc	TOTAL SLIP C	C/L TO MTG. FACE OF UJ's	BOLT HOLES	JOINT ANGLE	COMMENTS
7C-SCA-225	55.00-20 2.165	225.00 8.858	30.00 1.181		T	17	COVER TUBE TYPE
7C-SCA-390	55.00-20 2.165	390.00* 15.354	80.00* 3.150		T	25	COVER TUBE TYPE

Yoke Shaft & Slip not sold separately.

* Can be shortened to A=259, C=45

www.hardyspicer.com.au

Document No:	HSDSCAT
Issue:	8
Issue Date:	01/07/17

7C MECHANICS TYPE

BOLT HOLES:
S = STRAIGHT
T = THREADED

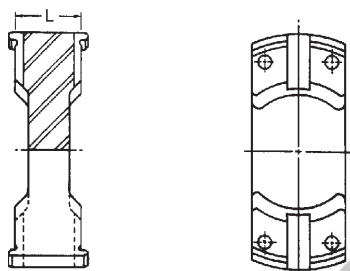

7C CENTRE PLATE

PART No.	MTG. FACE TO MTG. FACE L	BOLT HOLE	COMMENTS
7C-29-498#	44.45 1.750	S	USE 114-7206+ 114-7205 UJ's

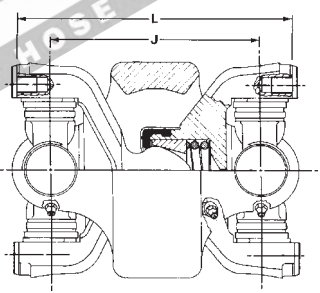

7CV DOUBLE CARDAN

PART No. COMPLETE ASSY.	OVERALL LENGTH L	C/LINE TO C/LINE J	UNIVERSAL JOINT TO SUIT	MAX ANGLE	COMMENTS
800-R7000#	213.60 8.406	162.80 6.406	114-7294	40°	COMPONENTS NOT SOLD SEPARATELY

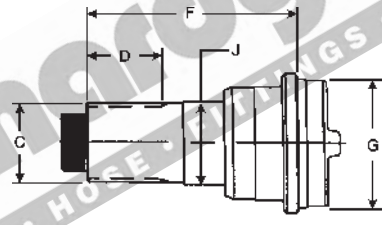

7C MIDSHIP STUB

PART No.	SPLINE O.D. & No. C	LENGTH OF SPLINE D	WELD TO END OF SPLINE F	TUBE PART No. & SIZE G	BEARING I.D. J	COMMENTS
7C-57-6011	50.80-31 2.000	47.75 1.880	184.15 7.250	3.500 x 0.115	61.98 2.440	USE 231502 NUT SUITS 7C-4-4801
7C-56-913EIMCO	44.45-10 1.750	54.00 1.880	123.00 4.843	3.000 x 0.120	49.20 1.937	AVAILABLE WHILE STOCKS LAST SUITS 7C-4-913EIMCO

INDENT ITEM

www.hardyspicer.com.au	
Document No:	HSDSCAT
Issue:	8
Issue Date:	01/07/17

MECHANICS TYPE 7C

BOLT HOLES:
S = STRAIGHT
T = THREADED

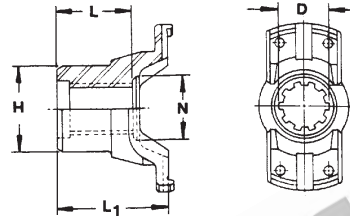

7C END YOKE

END YOKE PART No.	SPLINE DIA. & No.	LENGTH OF HOLE	HUB O.D.	NUT SEAT	MTG. FACE TO END OF SPLINE	BOLT HOLES	COMMENTS
	D	L	H	N	L1		
7C-4-4801	50.80-31 2.000	50.80 2.000	76.20 3.000		88.90 3.500	T	SUITS 7C-57-6011
7C-4-4291#	50.80-10 2.000	76.20 3.000	82.55 3.250	68.25 2.687	107.95 4.250	S	
7C-4-913EIMCO	44.45-10 1.750	58.20 2.291	76.10 2.996	63.70 2.508	101.60 4.000	T	SUITS 7C-56-913EIMCO AVAILABLE WHILE STOCKS LAST

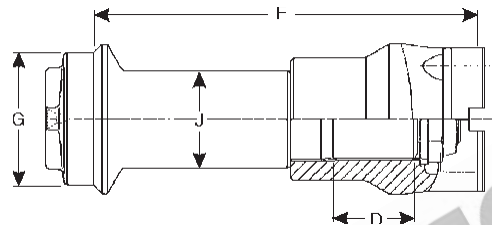

7C MIDSHIP ASSEMBLY

PART No.	SPLINE O.D. & No.	LENGTH OF SPLINE	WELD TO MOUNTING FACE	TUBE PART No. & SIZE	BEARING I.D.	COMMENTS
	C	D	F	G	J	
7C-56-254-60	50.80-16	52.00	254.00 10.000	88.90 x 4.06 3.500 x 0.160	60.00 2.362	AVAILABLE WHILE STOCKS LAST
7C-56-254-65	50.80-16	52.00	254.00 10.000	88.90 x 4.06 3.500 x 0.160	65.00 2.559	AVAILABLE WHILE STOCKS LAST

www.hardyspicer.com.au

Document No:	HSDSCAT
Issue:	8
Issue Date:	01/07/17

This catalogue is the copyright of Hardy Spicer

7C MECHANICS TYPE



www.hardyspicer.com.au

Document No:	HSDSCAT
Issue:	8
Issue Date:	01/07/17

MECHANICS TYPE 8C

E = 49.21
 1.93
 F = 174.63
 6.86
 C = 20.57
 0.81

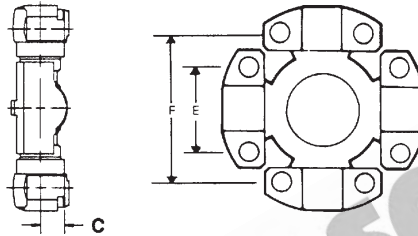

8C MECHANICS TYPE UNIVERSAL JOINT

S = STRAIGHT HOLE		T = THREADED HOLE	C = COUNTERSUNK HOLE
PART No.	LUBE	BEARING CAPS	
114-8113	SIDE	4 X BLOCK (S)	
114-8205	SIDE	4 X WING (T)	
114-8205R	SIDE	PREMIUM 4 X WING (T)	
114-8206	SIDE	2 X WING (C) 2 X WING (T)	
114-8207	SIDE	2 X BLOCK (S) 2 X WING (T)	
114-8207R	SIDE	PREMIUM 2 X BLOCK (S) 2 X WING (T)	
114-8113PL	NIL	PREMIUM PERMANENT LUBE, 4 X BLOCK (S)	
114-8113R	SIDE	PREMIUM, 4 X BLOCK (S)	

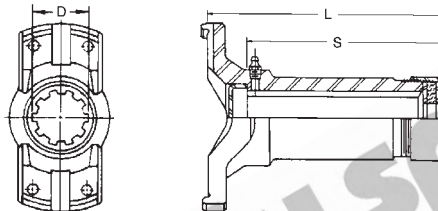

8C SLIP YOKE

PART No.	SPLINE O.D. & No.	MTG. FACE TO END OF SPLINE	LENGTH OF SPLINE	BOLT HOLES	JOINT ANGLE	DUST CAP	COMMENTS
	D	L	S				
8C-3-2650#	63.50-16 2.500	218.94 8.620	188.21 7.410	T	30	DCK8CB	

www.hardyspicer.com.au

Document No:	HSDSCAT
Issue:	8
Issue Date:	01/07/17

This catalogue is the copyright
of Hardy Spicer

8C MECHANICS TYPE

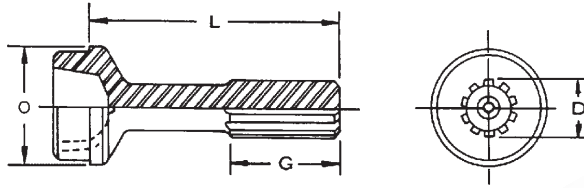

8C STUB

SPLINE TYPE:		HC = HARDY COATED ST = STEEL			BUTT TYPE:		H = HOLLOW S = SOLID		COMMENTS
PART No.	SPLINE DIA. & No.	SPLINE TYPE	LENGTH OF SPLINE	END OF SPLINE TO POINT OF WELD	BUTT TYPE	TUBE O.D. & THICKNESS	TUBE PART No.		
	D		G	L		O			
8C-42-5661#	63.50-16 2.500	ST	114.30 4.500	254.00 10.000	S	101.60 x 4.78 4.000 x 0.187			

Hardy Spicer 1700, 1710, 1760 Stubs may be used as an alternative

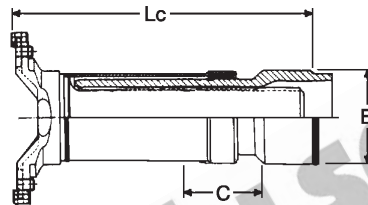

8C SLIP ASSEMBLY

PART No.	SPLINE O.D. & No.	MTG. FACE TO WELD POINT Lc	S=STRAIGHT BOLT HOLES		T=THREADED BOLT HOLES		COMMENTS
			TOTAL SLIP C	TUBE O.D. & WALL THICKNESS	BOLT HOLES	JOINT ANGLE	
8C-83-111	75.00-18 2.953	301.00 11.850	130.00 5.118	100.00 x 6.00 3.937 x .236	T	30°	

Yoke Shaft & Sleeve not sold separately.
Replacement Dust Cover and Seal Assembly - 8-5C-86-62

www.hardyspicer.com.au

Document No:	HSDSCAT
Issue:	8
Issue Date:	01/07/17

INDENT ITEM

MECHANICS TYPE 8C

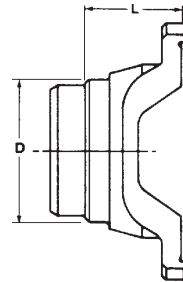

8C WELD YOKE

BOLT HOLES:		S=STRAIGHT T=THREAD		BUTT TYPE:			H=HOLLOW S=SOLID	
PART No.	MTG. FACE TO POINT OF WELD L	TUBE O.D. & WALL THICKNESS D	TUBE PART No.	BUTT TYPE	BOLT HOLES	MAX. ANGLE	COMMENTS	
8C-26-417	65.00 2.559	100.00 x 6.00 3.937 x 0.236	100X6MM	H	T	30		
8C-26-342#	68.33 2.690	101.60 x 4.78 4.000 x 0.187		H	T	30	CAN USE 100X4MM	

AVAILABLE WHILE STOCKS LAST

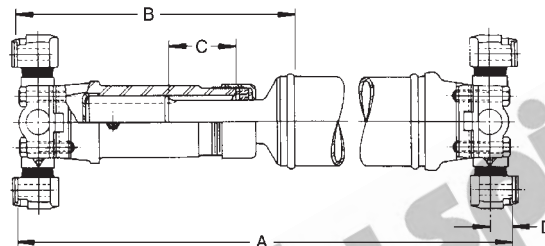

8C TUBULAR TYPE ASSEMBLY CHART

MINIMUM TUBE LENGTH = 60.0mm (2.36")									
BOLT HOLES		S=STRAIGHT T=THREADED			C/L TO MTG. FACE			D=20.57mm	
SLIP YOKE FEMALE PART No.	SLIP YOKE BOLT HOLES	STUB MALE PART No.	MTG. FACE TO POINT OF WELD CLOSED B	TOTAL SLIP C	CLOSED LENGTH MTG. FACE TO MTG. FACE WITH UJ's A	WELD YOKE PART No.	WELD YOKE BOLT HOLES	MAX ANGLE OF ASSY.	TUBE PART No. & SIZE
8C-3-2650	T	8C-42-5661	305.30 12.020	76.20 3.000	454.20 17.880	8C-26-342	T	30	Can use 100x4 4.000 x 0.187
8C-83-111	T	N/A	342.14 13.470	130.00 5.118	498.30 19.618	8C-26-417	T	30	100X6mm

www.hardyspicer.com.au

Document No:	HSDSCAT
Issue:	8
Issue Date:	01/07/17

This catalogue is the copyright of Hardy Spicer

8C MECHANICS TYPE

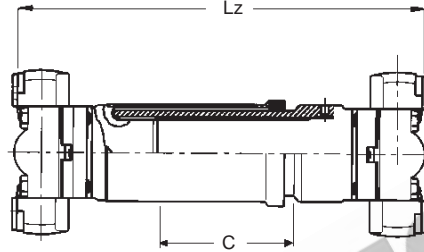

8C SHORT COUPLED SLIP ASSEMBLY

SHORT COUPLED ASSEMBLY PART No.	BOLT HOLES S=STRAIGHT T=THREADED	SPLINE SIZE & No.	TOTAL SLIP C	CLOSED LENGTH MTG. FACE TO MTG. FACE (INCL. UJ'S) Lz	MAX. ANGLE OF ASSY.	C/L TO MTG. FACE UJ'S	COMMENTS
8C-SCA-344#	T	75.00-28 2.952	65.00 2.559	344.00 13.543	25°	20.57 0.810	
Parts not sold separately							

BOLT HOLES:
S = STRAIGHT
T = THREADED

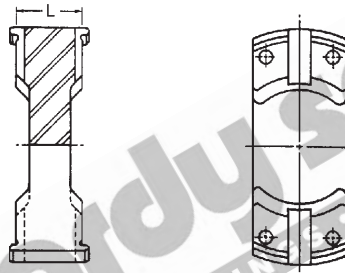

8C CENTRE PLATE

PART No.	MTG. FACE TO MTG. FACE FACE L	BOLT HOLE	COMMENTS
8C-29-496#	44.45 1.750	S	USE 114-8206+ 114-8205 UJ's

www.hardyspicer.com.au

Document No:	HSDSCAT
Issue:	8
Issue Date:	01/07/17

INDENT ITEM

MECHANICS TYPE 8-5C

E = 71.44
 2.81
 F = 123.83
 4.86
 C = 25.40

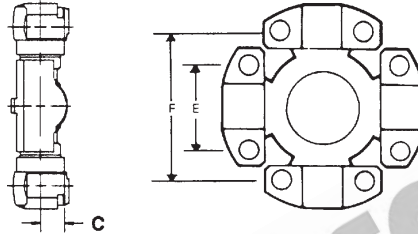

8-5C MECHANICS TYPE UNIVERSAL JOINT

S = STRAIGHT HOLE		T = THREADED HOLE	C = COUNTERSUNK HOLE
PART No.	LUBE	BEARING CAPS	
114-8516	SIDE	4 X BLOCK (S)	
114-8514	SIDE	4 X WING (T)	
114-8508	SIDE	2 X WING (T) 2 X BLOCK (S)	
114-8516PL	NIL	PREMIUM PERMANENT LUBE 4 X BLOCK (S)	
114-8516R	CENTRE	PREMIUM LUBE 4 X BLOCK (S)	
114-8516D	CENTRE	PREMIUM LUBE 4 X BLOCK (S) EURO	
114-8516PLD	NIL	PREMIUM PERMANENT LUBE 4 X BLOCK (S) EURO	

Bearing Cap Bolt **9C-73-76619** 12pt 1/2" bolt 2.250" long

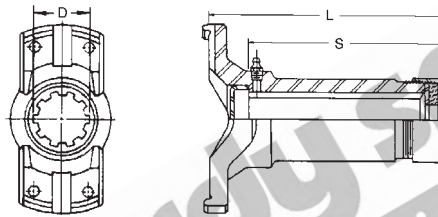

8-5C SLIP YOKE

PART No.	SPLINE O.D. & No.	MTG. FACE TO END OF SPLINE	LENGTH OF SPLINE	BOLT HOLES	JOINT ANGLE	DUST CAP	COMMENTS
	D	L	S				
8-5C-3-2750	63.50-16 2.500	219.08 8.625	190.50 7.500	T	25	DCK8CB	AVAILABLE WHILE STOCKS LAST

www.hardyspicer.com.au

Document No:	HSDSCAT
Issue:	8
Issue Date:	01/07/17

8-5C MECHANICS TYPE

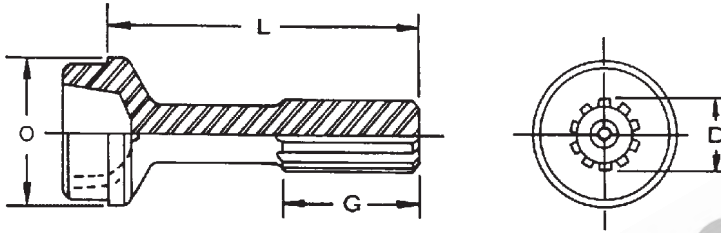

8-5C STUB

SPLINE TYPE:		HC = HARDY COATED ST = STEEL			BUTT TYPE:		H = HOLLOW S = SOLID		COMMENTS
PART No.	SPLINE DIA. & No.	SPLINE TYPE	LENGTH OF SPLINE	END OF SPLINE TO POINT OF WELD	BUTT TYPE	TUBE O.D. & THICKNESS	TUBE PART No.		
	D		G	L		O			
8C-42-5661	63.50-16 2.500	ST	114.30 4.500	254.00 10.000		101.60 x 2.77 4.000 x 0.109		AVAILABLE WHILE STOCKS LAST	

Hardy Spicer 1700, 1710, 1760 Stubs may be used as an alternative

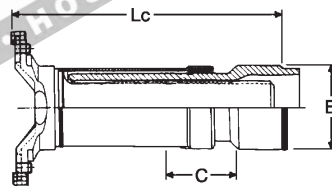

8-5C SLIP ASSEMBLY

S=STRAIGHT BOLT HOLES				T=THREADED BOLT HOLES			COMMENTS
PART No.	SPLINE O.D. & No.	MTG. FACE TO WELD POINT	TOTAL SLIP	TUBE O.D. & WALL THICKNESS	BOLT HOLES	JOINT ANGLE	
		Lc	C				
8-5C-83-101	68.00-38 2.677	290.00 11.417	130.00 5.118	100.00 x 6.00 3.937 x 0.236	T	25	

Yoke Shaft & Sleeve not sold separately. Replacement Dust Cover & Seal Assy = 6-687-450900300#

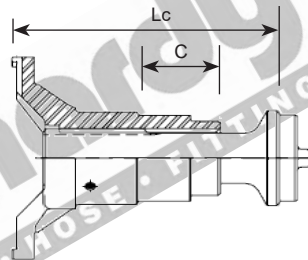

8-5C SLIP/STUB ASSEMBLY

S=STRAIGHT BOLT HOLES				T=THREADED BOLT HOLES			COMMENTS
PART No.	SPLINE O.D. & No.	MTG. FACE TO WELD POINT	TOTAL SLIP	TUBE O.D. & WALL THICKNESS	BOLT HOLES	JOINT ANGLE	
		Lc	C				
8.5C-84-264	63.50-16 2.500	272.00 10.709	88.00 3.465	103.89 x 4.57 4.090 x .180	T		COATED STUB

Slip & Stub sold as assembly

www.hardyspicer.com.au

Document No:	HSDSCAT
Issue:	8
Issue Date:	01/07/17

INDENT ITEM

MECHANICS TYPE 8-5C

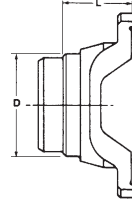

8-5C

WELD YOKE

BOLT HOLES:		S=STRAIGHT T=THREAD		BUTT TYPE:		H=HOLLOW S=SOLID		COMMENTS
PART No.	MTG. FACE TO POINT OF WELD L	TUBE O.D. & WALL THICKNESS D	TUBE PART No.	BUTT TYPE	BOLT HOLES	MAX. ANGLE		
8-5C-28-851	66.04 2.600	103.89 x 4.57 4.090 x 0.180	3207-0000	H	T	25	STANDARD	
8-5C-26-390	65.00 2.559	100.00 x 6.00 3.937 x 0.236	100X6MM	H	T	25		

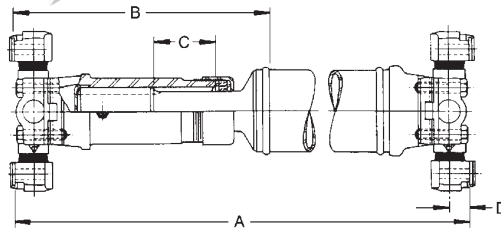

FIG 1

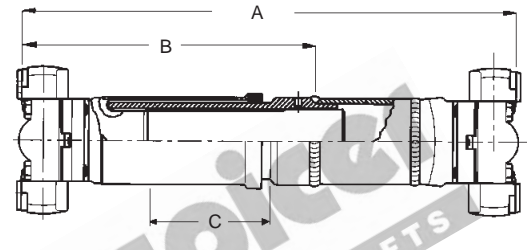

FIG 2

8-5C

TUBULAR TYPE ASSEMBLY CHART

MINIMUM TUBE LENGTH = 60.0mm (2.36")									
BOLT HOLES		S=STRAIGHT T=THREADED			C/L TO MTG. FACE D=25.40mm				
SLIP YOKE FEMALE PART No.	SLIP YOKE BOLT HOLES	STUB MALE PART No.	U/J FACE TO POINT OF WELD CLOSED	TOTAL SLIP	CLOSED LENGTH MTG. FACE TO MTG. FACE WITH UJ's	WELD YOKE PART No.	WELD YOKE BOLT HOLES	MAX ANGLE OF ASSY.	TUBE PART No. & SIZE
			B	C	A				
8-5C-3-2750 (FIG 1)	T	8-5C-42-5661	315.40 12.410	76.20 3.000	477.00 18.770	8-5C-28-851	T	25	101.60 x 4.750 4.000 x 0.187
SLIP / STUB ASSEMBLY PART No.			B	C	A				
8-5C-83-101 Sleeve type (FIG 2)			340.80 13.417	130.00 5.118	506.60 19.945	8-5C-26-390	T	25	100X6MM 3.937 x 0.236
8-5C-84-264 Slip/Stub type (FIG 1)			322.80 12.709	88.00 3.465	489.60 19.276	8-5C-28-851	T		3207-0000 4.090 x 0.180

www.hardyspicer.com.au

Document No:	HSDSCAT
Issue:	8
Issue Date:	01/07/17

8-5C MECHANICS TYPE

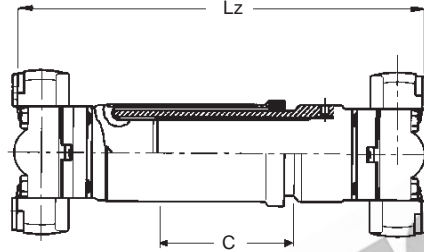

8-5C SHORT COUPLED ASSEMBLY CHART

SHORT COUPLED ASSEMBLY PART No.	BOLT HOLES S=STRAIGHT T=THREADED	SPLINE SIZE & No.	TOTAL SLIP	CLOSED LENGTH MTG. FACE TO MTG. FACE (INCL. UJ'S)	MAX. ANGLE OF ASSY.	C/L TO MTG. FACE UJ'S	COMMENTS
			C	Lz			
8-5C-SCA-310#*	T	75.00-28 2.952	65.00 2.559	310.00 12.205	25°	25.4 1.000	SUPPLIED WITH UJ'S 114-8516D
8-5C-SCA-368#*	T	75.00-28 2.952	85.00 3.346	368.00 14.488	25°	25.4 1.000	SUPPLIED WITH UJ'S 114-8516D

Parts not sold separately
*Make from parts below

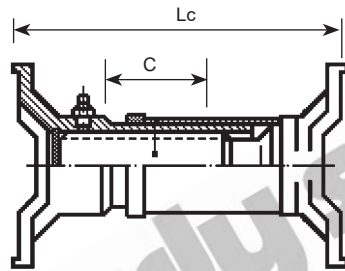

8-5C SHORT COUPLED SHAFT

SHORT COUPLED SHAFT PART No.	BOLT HOLES S=STRAIGHT T=THREADED	SPLINE SIZE & No.	TOTAL SLIP	CLOSED LENGTH FACE - FACE	MAX. ANGLE OF ASSY.	COMMENTS
			C	Lc		
8-5C-83-210	T	75.00-28 2.952	65.00 2.559	208.40 8.205	25°	USE TO MAKE 8-5C-SCA-310
8-5C-83-240	T	75.00-28 2.952	85.00 3.346	238.40 9.386	25°	USE TO MAKE 8-5C-SCA-340
8-5C-83-268	T	75.00-28 2.952	85.00 3.346	266.40 10.488	25°	USE TO MAKE 8-5C-SCA-368

www.hardyspicer.com.au

Document No:	HSDSCAT
Issue:	8
Issue Date:	01/07/17

INDENT ITEM

MECHANICS TYPE 8-5C

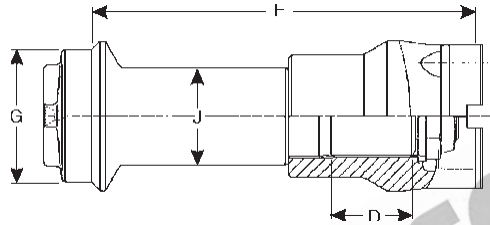

8-5C

MIDSHIP ASSEMBLY

PART No.	SPLINE O.D. & No.	LENGTH OF SPLINE	WELD TO MOUNTING FACE	TUBE PART No. & SIZE	BEARING I.D.	COMMENTS
	C	D	F	G	J	
8-5C-56-6040	60.00-34 INV 2.362	55.00 2.165	255.00 10.039	100.00 x 6.00 3.937 x 0.236	65.00 2.559	MS NUT - 509-60
8-5C-56-1085	60.30-46 INV 2.374	60.00 2.362	267.00 10.512	102.00 x 5.00 3.937 x 0.236	65.00 2.559	

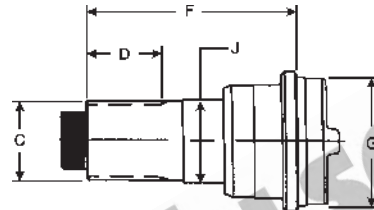

8-5C

MIDSHIP STUB

PART No.	SPLINE O.D. & No.	LENGTH OF SPLINE	END OF SPLINE TO POINT OF WELD	TUBE PART No. & SIZE	BEARING DIAMETER	COMMENTS
	C	D	F	G	J	
8-5C-57-78363#	2.35-46 INV 59.69	2.811 71.40	8.250 209.55	4.000 x 0.188	65.00 2.559	USE 9C-4-6046 END YOKE 1/2" UNF BOLT

www.hardyspicer.com.au

Document No:	HSDSCAT
Issue:	8
Issue Date:	01/07/17

This catalogue is the copyright of Hardy Spicer

8-5C MECHANICS TYPE



www.hardyspicer.com.au

Document No:	HSDSCAT
Issue:	8
Issue Date:	01/07/17

MECHANICS TYPE 9C

E = 71.44
 2.81
 F = 168.30
 6.61
 C = 25.40
 1.00

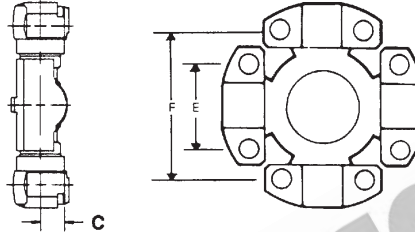

9C MECHANICS TYPE UNIVERSAL JOINT

S = STRAIGHT HOLE		T = THREADED HOLE	C = COUNTERSUNK HOLE
PART No.	LUBE	BEARING CAPS	
114-9014	SIDE	4 X WING (T)	
114-9015	SIDE	4 X WING (C)	
114-9016	SIDE	4 X BLOCK (S)	
114-9017	SIDE	2 X BLOCK (S) 2 X WING (T)	
114-9026	SIDE	2 X WING (C) 2 X WING (T)	
114-9038	CENTRE	4 X BLOCK (S)	
114-9016PL	NIL	PREMIUM PERMANENT LUBE, 4 X BLOCK (S) USA	
114-9016R	SIDE	PREMIUM LUBE 4 X BLOCK (S) USA	
114-9016D	SIDE	PREMIUM LUBE 4 X BLOCK (S) EURO	
114-9016PLD	NIL	PREMIUM, 4 X BLOCK (S) EURO	

Bearing Cap Bolt **9C-73-76619** 12pt 1/2" bolt 2.250" long
 Bearing Cap Bolt **9C-73-84971** 12pt M12x1.75 bolt 60mm long

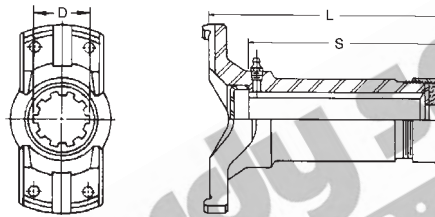

9C SLIP YOKE

PART No.	SPLINE O.D. & No.	MTG. FACE TO END OF SPLINE	LENGTH OF SPLINE	BOLT HOLES	JOINT ANGLE	DUST CAP	COMMENTS
	D	L	S				
9C-3-2570	76.20-16 3.000	244.48 9.625	212.73 8.375	T	30	DCK9CA	NO LONGER AVAILABLE
9C-3-3570	76.20-16 3.000	295.10 11.618	236.50 9.311	T	30	DCK9CA	STANDARD

www.hardyspicer.com.au

Document No:	HSDSCAT
Issue:	8
Issue Date:	01/07/17

This catalogue is the copyright of Hardy Spicer

9C MECHANICS TYPE

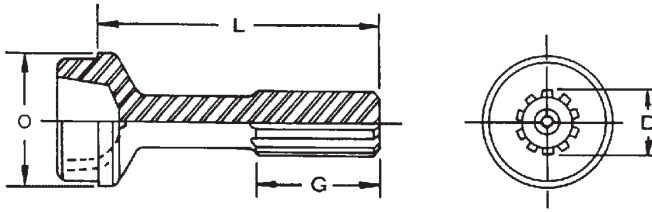

9C STUB

SPLINE TYPE:		HC = HARDY COATED ST = STEEL			BUTT TYPE:		H = HOLLOW S = SOLID		COMMENTS
PART No.	SPLINE DIA. & No.	SPLINE TYPE	LENGTH OF SPLINE	END OF SPLINE TO POINT OF WELD	BUTT TYPE	TUBE O.D. & THICKNESS	TUBE PART No.		
	D		G	L		O			
9C-42-5611	76.20-16 3.000	ST	136.52 5.370	284.15 11.180	S	114.30 x 6.35 4.500 x 0.250		NO LONGER AVAILABLE	
9C-42-6091	76.20-16 3.000	HC	163.60 6.441	322.30 12.689	S	114.30 x 9.53 4.500 x 0.375	114-3X9-53MM	STANDARD	

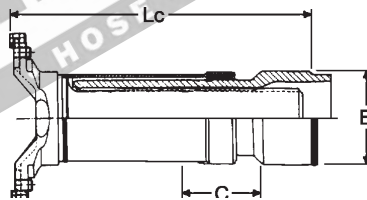

9C SLIP ASSEMBLY

S=STRAIGHT BOLT HOLES				T=THREADED BOLT HOLES			
PART No.	SPLINE O.D. & No.	MTG. FACE TO WELD POINT Lc	TOTAL SLIP C	TUBE O.D. & WALL THICKNESS	BOLT HOLES	JOINT ANGLE	COMMENTS
9C-83-104	78.00-38 3.071	297.00 11.692	150.00 5.906	115.00 x 7.50 4.528 x 0.295	T	25	

Yoke Shaft & Sleeve not sold separately.
Replacement Dust Cover & Seal Assy = 6-687-550900030#

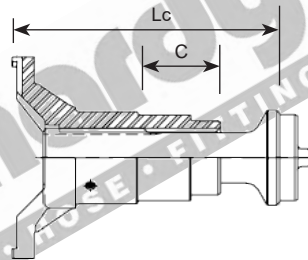

9C SLIP/STUB ASSEMBLY

S=STRAIGHT BOLT HOLES				T=THREADED BOLT HOLES			
PART No.	SPLINE O.D. & No.	MTG. FACE TO WELD POINT Lc	TOTAL SLIP C	TUBE O.D. & WALL THICKNESS	BOLT HOLES	JOINT ANGLE	COMMENTS
9C-84-320	76.20-16 3.000	320.00 12.598	127.00 5.000	114.30 x 6.58 4.500 x .259	T		COATED STUB

Slip & Stub sold as assembly

www.hardyspicer.com.au

Document No:	HSDSCAT
Issue:	8
Issue Date:	01/07/17

INDENT ITEM

MECHANICS TYPE 9C

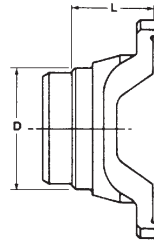

9C

WELD YOKE

BOLT HOLES:		S=STRAIGHT T=THREAD		BUTT TYPE:		H=HOLLOW S=SOLID		COMMENTS
PART No.	MTG. FACE TO POINT OF WELD L	TUBE O.D. & WALL THICKNESS D	TUBE PART No.	BUTT TYPE	BOLT HOLES	MAX. ANGLE		
9C-26-386	73.00 2.874	115.00 x 7.50 4.527 x 0.295	115X7-1/2MM	H	T	25 0.250"		
9C-28-900	62.00 2.441	114.30 x 6.59 4.500 x 0.259	3603-0000	H	T	30 0.250"	REPLACES 9C-26-326 1/2" THREADED HOLES	
9C-26-411	65.00 2.559	115.00 x 7.50 4.527 x 0.295	115X7-1/2MM	H	T	25 M12x1.75	METRIC THREADS	
9C-26-415	63.50 2.500	114.30 x 9.53 4.500 x 0.375	114-3X9-53MM		T	30 M12x1.75	STANDARD	

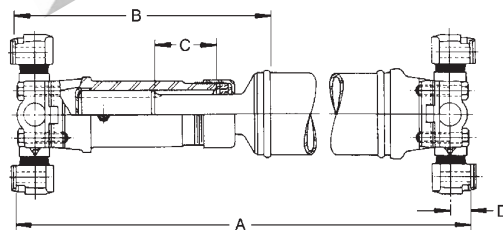

FIG 1

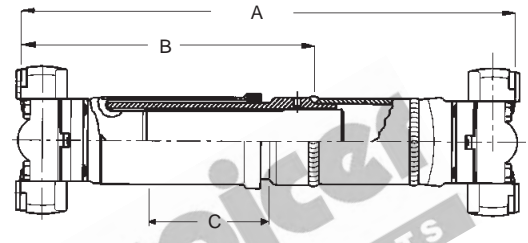

FIG 2

9C

TUBULAR TYPE ASSEMBLY CHART

MINIMUM TUBE LENGTH = 60.0mm (2.36")									
BOLT HOLES		S=STRAIGHT T=THREADED			C/L TO MTG. FACE		D=25.40mm		
SLIP YOKE FEMALE PART No.	SLIP YOKE BOLT HOLES	STUB MALE PART No.	U/J FACE TO POINT OF WELD CLOSED B	TOTAL SLIP C	CLOSED LENGTH MTG. FACE TO MTG. FACE WITH UJ's A	WELD YOKE PART No.	WELD YOKE BOLT HOLES	MAX ANGLE OF ASSY.	TUBE PART No. & SIZE
9C-3-3570 (FIG 1)	T	9C-42-6091	404.88 15.940	101.60 4.000	569.98 22.440	9C-26-415	T	30	114-3X9-53MM 4.500 x 0.375
SLIP / STUB ASSEMBLY									
PART No.			B	C	A				
9C-83-104 Sleeve type (FIG 2)			347.80 13.693	150.00 5.906	521.00 20.512	9C-26-386	T	25	115X7-1/2MM 115.00 x 7.50mm
9C-84-320 Slip/Stub type (FIG 1)			370.80 14.598	127.00 5.000	543.60 21.402	9C-28-900	T	30	3603-0000 4.500 x 0.259

www.hardyspicer.com.au

Document No:	HSDSCAT
Issue:	8
Issue Date:	01/07/17

9C MECHANICS TYPE

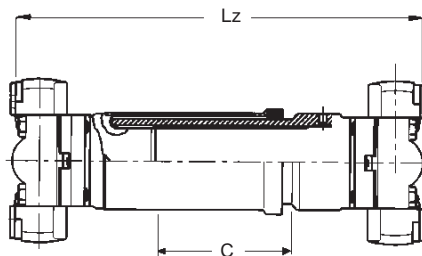

9C SHORT COUPLED ASSEMBLY

SHORT COUPLED ASSEMBLY PART No.	BOLT HOLES S=STRAIGHT T=THREADED	SPLINE SIZE & No.	TOTAL SLIP C	CLOSED LENGTH MTG. FACE TO MTG. FACE (INCL. UJ'S) Lz	MAX. ANGLE OF ASSY.	C/L TO MTG. FACE UJ'S	COMMENTS
9C-SCA-347*	T	90.00-34 3.543	72/40 2.835	347/325 13.661/12.795	25°	25.4 1.000	INCL. 2 x 114-9016D
9C-SCA-391	T	90.00-34 3.543	75/40 2.953	391/325 15.394/12.795	25°	25.4 1.000	INCL. 2 x 114-9016D

Yoke Shaft & Slip not sold separately. *Available while stocks last.

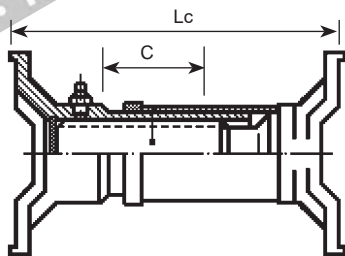

9C SHORT COUPLED SLIP ASSEMBLY

SHORT COUPLED ASSEMBLY PART No.	BOLT HOLES S=STRAIGHT T=THREADED	SPLINE SIZE & No.	TOTAL SLIP C	CLOSED LENGTH FACE TO FACE OF YOKES Lc	MAX. ANGLE OF ASSY.	COMMENTS
9C-SCA-245	T	90.00-34 3.543	72/40 2.835	245/225 9.646	25°	MAKES 9C-SCA-347

Yoke Shaft & Slip not sold separately

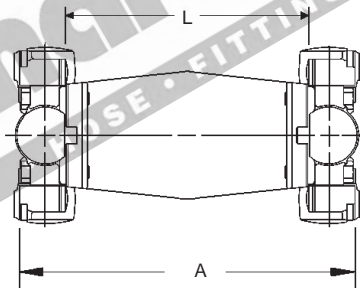

9C CLOSE COUPLED ASSEMBLY

PART No. COMPLETE ASSY.	OVERALL LENGTH A	CENTRE PLATE WIDTH L	UNIVERSAL JOINT TO SUIT	MAX ANGLE	COMMENTS
9C-CCA-75519	215.90 8.500	114.30 4.500	114-9016R		

www.hardyspicer.com.au

Document No:	HSDSCAT
Issue:	8
Issue Date:	01/07/17

MECHANICS TYPE 9C

BOLT HOLES:
S = STRAIGHT
T = THREADED

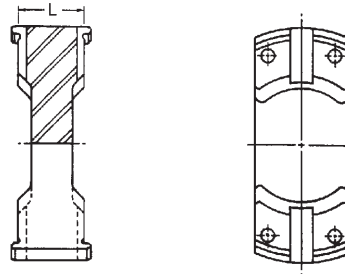

9C CENTRE PLATE

PART No.	MTG. FACE TO MTG. FACE L	BOLT HOLE	COMMENTS
9C-29-509#	50.80 2.000	T	USE 114-9016 UJ's BOTH SIDES

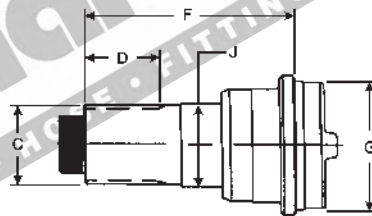

9C MIDSHIP STUB

PART No.	SPLINE O.D. & No.	LENGTH OF SPLINE	END OF SPLINE TO POINT OF WELD	TUBE PART No. & SIZE	BEARING DIAMETER	COMMENTS
	C	D	F	G	J	
9C-57-5991	72.23-22 2.844	73.41 2.890	221.23 8.710	114.30 x 6.35 4.500 x 0.250	75.00 2.950	USE 3/4" - 16 BOLT SUITS 9C-4-4791
9C-57-6001	74.61-46 2.938	81.03 3.190	213.11 8.390	127.00 x 9.53 5.000 x 0.375	74.93 2.950	USE 1" - 20 BOLT
6-5-53-51	59.69-16 2.350	69.85 2.750	138.12 5.438	114.30 x 6.58 4.500 x 0.259	60.00 2.362	USE 9C-4-1891 & 210875-1X

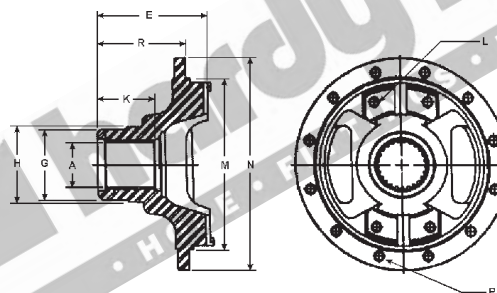

9C BRAKE YOKE

PART No.	SPLINE O.D. & No.	SPLINE LENGTH	LENGTH	OVERALL	HUB DIA.	SPIGOT DIA.	O.D.	MOUNTING HOLE SIZE	FLANGE HOLE SIZE
	A	K	R	E	G	M	N	L	P
9C-4-4791	76.20-22 3.000	84.33 3.320	141.73 5.580	171.70 6.760	108.46 4.270	222.76 8.770	276.10 10.870	1/2"-20	1/2"-13
Suits 9C-57-5991 Midship Stub									

INDENT ONLY

www.hardyspicer.com.au

Document No:	HSDSCAT
Issue:	8
Issue Date:	01/07/17

This catalogue is the copyright of Hardy Spicer

9C MECHANICS TYPE

BOLT HOLES:
S = STRAIGHT
T = THREADED

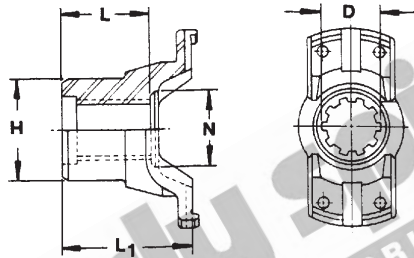

9C END YOKE

END YOKE PART NO.	SPLINE DIA. & No. D	LENGTH OF HOLE L	HUB O.D. H	NUT SEAT N	MTG.FACE TO END OF SPLINE	BOLT HOLES	COMMENTS
9C-4-3647	57.15-10 2.250	76.20 3.000	73.15 2.880		106.38 4.188	T	SUITS 8-53-41 MACK
9C-4-6046	59.70-46 2.350	80.00 3.150	76.20 3.000	86.00 3.386	122.00 4.803	T	M12x1.75 THREADED HOLES CATERPILLAR APPLICATIONS SUITS 8-5C-57-78363
9C-4-1891	59.70-16 2.350	69.85 2.750	73.03 2.875		105.00 4.134	T	SUITS 6-5-53-91 & 6-5-53-51

www.hardyspicer.com.au

Document No:	HSDSCAT
Issue:	8
Issue Date:	01/07/17

MECHANICS TYPE 9.5C

E = 71.44
 2.81
 F = 168.30
 6.61
 C = 28.14
 1.11

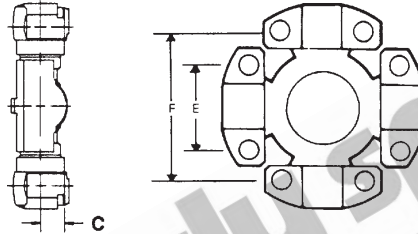

9.5C MECHANICS TYPE UNIVERSAL JOINT

S = STRAIGHT HOLE		T = THREADED HOLE	C = COUNTERSUNK HOLE
PART No.	LUBE	BEARING CAPS	
114-9500	NIL	4 X BLOCK (S) MECHANICS 9-5C / TWIN DISC J310 SERIES	

USE
 9C SERIES
 SLEEVE TYPE
 MATCHING COMPONENTS

www.hardyspicer.com.au

Document No:	HSDSCAT
Issue:	8
Issue Date:	01/07/17

9.5C MECHANICS TYPE



www.hardyspicer.com.au

Document No:	HSDSCAT
Issue:	8
Issue Date:	01/07/17

MECHANICS TYPE 10C

E = 92.07
 3.62
 F = 165.10
 6.48
 C = 32.51
 1.28

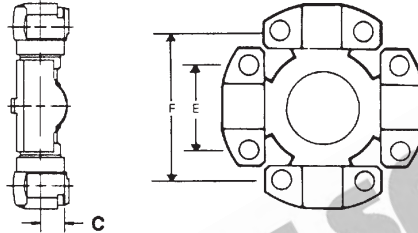

10C MECHANICS TYPE UNIVERSAL JOINT

S = STRAIGHT HOLE		T = THREADED HOLE	C = COUNTERSUNK HOLE
PART No.	LUBE	BEARING CAPS	
114-10003	SIDE	4 X BLOCK (S) (9/16 BOLTS)	
114-10007	SIDE	4 X WING (S) (5/8 BOLTS)	
114-10011R	SIDE	PREMIUM 4 X BLOCK (S) (5/8 BOLTS) USA	
114-10011W	SIDE	4 X BLOCK (S) (5/8 BOLTS)	
114-10011PL	NIL	PREMIUM PERMANENT LUBE 4 X BLOCK (S) (5/8 BOLTS) USA	
114-10011D	SIDE	PREMIUM RE-LUBE (S) EURO	
114-10011PLD	NIL	PREMIUM PERMANENT LUBE (S) EURO	
114-10033	SIDE	4 X BLOCK (S) (5/8 BOLTS) 10C X 10.5C SERIES (J490 SERIES)	

Bearing Cap Bolt **10C-73-72424** 12pt 5/8" bolt 3.250" long
 Bearing Cap Bolt **10C-73-74613** Hex M16x2.0 bolt 80mm long

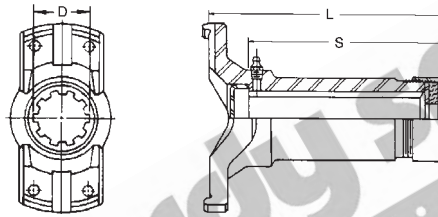

10C SLIP YOKE

PART No.	SPLINE O.D. & No.	MTG. FACE TO END OF SPLINE	LENGTH OF SPLINE	BOLT HOLES	JOINT ANGLE	DUST CAP	COMMENTS
	D	L	S				
10C-3-3460	85.72-32	304.80	260.40	T	25	DCK10CA	5/8" BOLT HOLES
INVOLUTE SPLINE	3.375	12.000	10.250				

www.hardyspicer.com.au

Document No:	HSDSCAT
Issue:	8
Issue Date:	01/07/17

This catalogue is the copyright of Hardy Spicer

10C MECHANICS TYPE

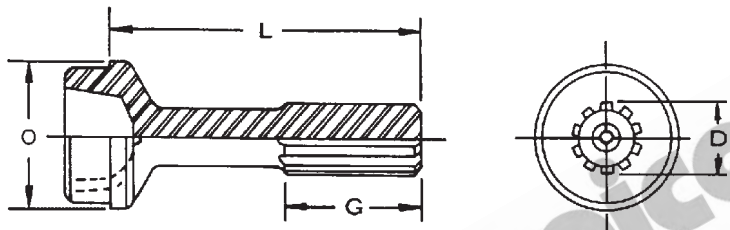

10C STUB

SPLINE TYPE:		HC = HARDY COATED ST = STEEL			BUTT TYPE:		H = HOLLOW S = SOLID		COMMENTS
PART No.	SPLINE DIA. & No. D	SPLINE TYPE	LENGTH OF SPLINE G	END OF SPLINE TO POINT OF WELD L	BUTT TYPE	TUBE O.D. & THICKNESS O	TUBE PART No.		
10C-42-5961 INVOLUTE SPLINE	85.72-32 3.375	ST	143.00 5.630	315.00 12.401	S	127.00 x 9.53 5.000 x 0.375	127X9-53MM	STANDARD	

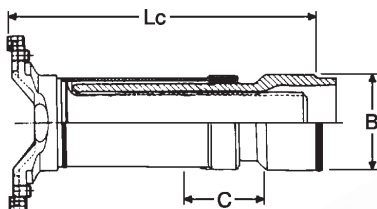

10C SLIP ASSEMBLY

S=STRAIGHT BOLT HOLES				T=THREADED BOLT HOLES			COMMENTS
PART No.	SPLINE O.D. & No.	MTG. FACE TO WELD POINT Lc	TOTAL SLIP C	TUBE O.D. & WALL THICKNESS	BOLT HOLES	JOINT ANGLE	
10C-83-102 INVOLUTE SPLINE	90.00-34 3.543	391.00 15.394	150.00 5.906	140.00 x 5.00 5.512 x 0.197	T	25	5/8 THREADED
10C-83-102M# INVOLUTE SPLINE	90.00-34 3.543	391.00 15.394	150.00 5.906	140.00 x 5.00 5.512 x 0.197	T	25	M16x2 THREADED HOLE

Yoke Shaft & Sleeve not sold separately. Replacement Dust Cover & Seal Assy = 10C-86-63 or 6-587-500900030
INDENT ONLY

www.hardyspicer.com.au

Document No:	HSDSCAT
Issue:	8
Issue Date:	01/07/17

MECHANICS TYPE 10C

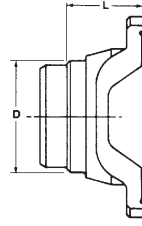

10C

WELD YOKE

BOLT HOLES:		S=STRAIGHT T=THREAD		BUTT TYPE:		H=HOLLOW S=SOLID		COMMENTS
PART No.	MTG. FACE TO POINT OF WELD L	TUBE O.D. & WALL THICKNESS D	TUBE PART No.	BUTT TYPE	BOLT HOLES	MAX. ANGLE		
10C-26-389	85.00 3.346	140.00 x 5.00 5.512 x 0.197	140X5MM*	H	T	25	5/8 THREADED HOLES	
10C-26-388	98.60 3.880	127.00 x 9.53 5.000 x 0.375	127X9-53MM	H	T	25	5/8 THREADED HOLES	
10C-26-412	85.00 3.346	140.00 x 5.00 5.512 x 0.197	140X5MM*	H	T	25	M16x2 THREADED HOLES	

* CAN USE 142X6MM OR 144X7MM FOR HEAVY DUTY APPLICATIONS

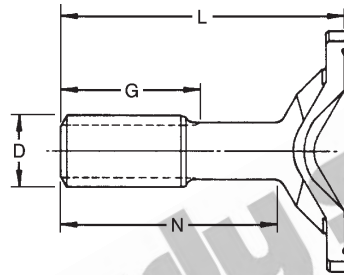

10C

STUB YOKE

SPLINE TYPE:		HC = HARDY COATED ST = STEEL			BUTT TYPE:		H = HOLLOW S = SOLID		COMMENTS
PART No.	SPLINE DIA. & No. D	LENGTH OF SPLINE G	MTG. FACE TO END OF SPLINE L	SHOULDER TO END OF SPLINE N	BOLT HOLES	SPLINE TYPE O	MAX. ANGLE		
10C-82-3451# INVOLUTE SPL	85.72-32 3.375		473.00 18.622		S	INV		SUITS 10C-3-3460	

www.hardyspicer.com.au

Document No:	HSDSCAT
Issue:	8
Issue Date:	01/07/17

This catalogue is the copyright of Hardy Spicer

10C MECHANICS TYPE

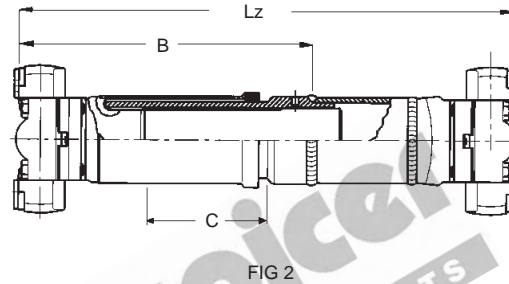
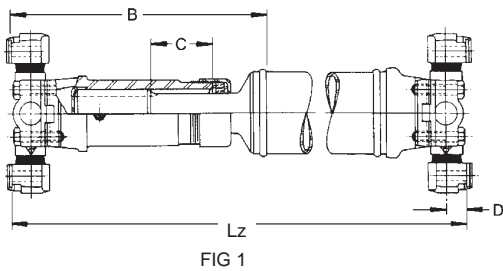

10C TUBULAR TYPE ASSEMBLY CHART

MINIMUM TUBE LENGTH = 52.09mm (2.050")

BOLT HOLES		S=STRAIGHT T=THREADED			C/L TO MTG. FACE D=32.51mm				
SLIP YOKE FEMALE PART No.	SLIP YOKE BOLT HOLES	STUB MALE PART No.	MTG. FACE OF UJ TO POINT OF WELD CLOSED	TOTAL SLIP	CLOSED LENGTH MTG. FACE TO MTG. FACE WITH UJ's	WELD YOKE PART No.	WELD YOKE BOLT HOLES	MAX ANGLE OF ASSY.	TUBE PART No. & SIZE
			B	C	Lz				
10C-3-3460 (FIG 1)	T	10C-42-5961 INVOLUTE SPLINE	424.43 16.710	127.00 5.000	628.00 24.724	10C-26-388	T	25	127X9-53MM 5.000 x 0.375
SLIP / STUB ASSEMBLY									
PART No.			B	C	Lz				
10C-83-102 Sleeve type (FIG 2)			456.00 17.953	150.00 5.906	656.00 25.827	10C-26-389	T	25	140X5MM* 140.00 x 5.00mm

* CAN USE 142X6MM OR 144X7MM FOR HEAVY DUTY APPLICATIONS

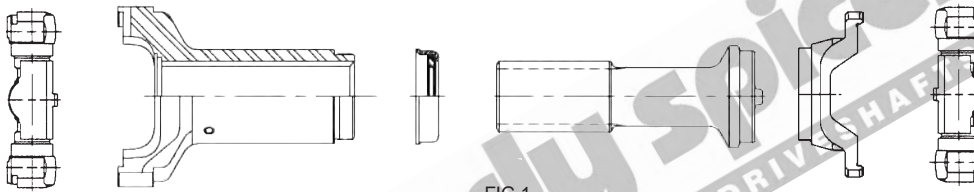

FIG 1

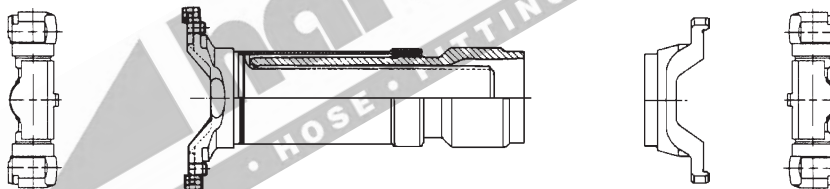

FIG 2

10C PSA KITS

KIT PART No.	UNIVERSAL JOINTS	SLIP ASSEMBLY	WELD YOKE	TUBE TO SUIT (NOT INCL.)	COMMENTS
	1	2	3		
10C-PSA-KIT (FIG 1)	114-10011R (2 off)	10C-3-3460 10C-42-5961	10C-26-388	127X9-53MM	USA kit (Slip / Stub type splines)
10C-PSA-KIT-IC (FIG 2)	114-10011R (2 off)	10C-83-102	10C-26-389	140X5MM	EURO kit (Cover Sleeve type splines)

www.hardyspicer.com.au

Document No:	HSDSCAT
Issue:	8
Issue Date:	01/07/17

MECHANICS TYPE 10C

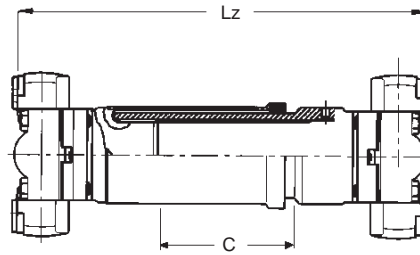

10C SHORT COUPLED SLIP ASSEMBLY

S=STRAIGHT BOLT HOLES				T=THREADED BOLT HOLES			
PART No.	SPLINE O.D. & No.	MTG. FACE TO MTG FACE CLOSED Lz	TOTAL SLIP C	C/L TO MTG. FACE OF UJ's	BOLT HOLES	JOINT ANGLE	COMMENTS
10C-SCA-440	90.00-34 3.543	440.00 17.323	95.00 3.740	32.51 1.280	T		COVER TUBE TYPE

Yoke Shaft & Slip not sold separately.

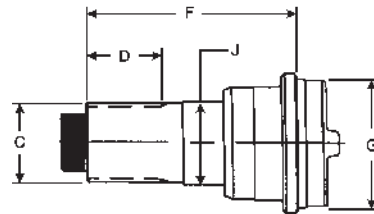

10C MIDSHIP STUB

PART No.	SPLINE O.D. & No.	LENGTH OF SPLINE D	END OF SPLINE TO POINT OF WELD F	TUBE PART No. & SIZE G	BEARING DIAMETER J	COMMENTS
9C-57-6001	74.61-46 2.938	81.03 3.190	213.11 8.390	127.00 x 9.53 5.000 x 0.375	74.93 2.950	USE 1" - 20 BOLT

BOLT HOLES:
S = STRAIGHT
T = THREADED

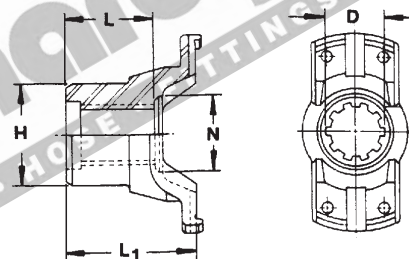

10C END YOKE

END YOKE PART No.	SPLINE DIA. & No.	LENGTH OF HOLE L	HUB O.D. H	NUT SEAT N	MTG.FACE TO END OF SPLINE	BOLT HOLES	COMMENTS
14C-4-77483	74.60-46 2.940	76.20 3.000	101.60 4.000		135.70 5.340	T	SUITS 9C-57-6001 MIDSHIP STUB

www.hardyspicer.com.au

Document No:	HSDSCAT
Issue:	8
Issue Date:	01/07/17

10C MECHANICS TYPE



www.hardyspicer.com.au

Document No:	HSDSCAT
Issue:	8
Issue Date:	01/07/17

MECHANICS TYPE 10-5C

E = 88.90
 3.49
 F = 172.72
 6.78
 C = 34.04
 1.34

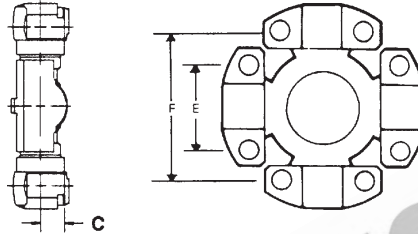

10-5C MECHANICS TYPE UNIVERSAL JOINT

S = STRAIGHT HOLE		T = THREADED HOLE	C = COUNTERSUNK HOLE
PART No.	LUBE	BEARING CAPS	
114-10500	SIDE	4 X BLOCK (S) (5/8 BOLTS) MECHANICS 10-5C / TWIN DISC J490 SERIES	
114-10033	SIDE	10C TO 10-5C CONVERSION UNIVERSAL JOINT	

Bearing Cap Bolt **10C-73-72424** 12pt 5/8" bolt 3.250" long

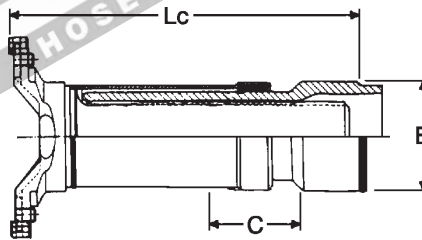

10-5C SLIP ASSEMBLY

S=STRAIGHT BOLT HOLES				T=THREADED BOLT HOLES			
PART No.	SPLINE O.D. & No.	MTG. FACE TO WELD POINT Lc	TOTAL SLIP C	TUBE O.D. & WALL THICKNESS	BOLT HOLES	JOINT ANGLE	COMMENTS
10-5C-83-103#	127.00-29 5.000	380.00 14.960	127.00 5.000	142.24 x 6.43 5.600 x 0.253	T	20	5/8 THREADED HOLES

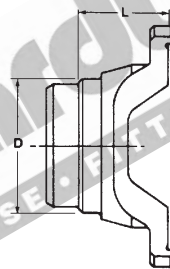

10-5C WELD YOKE

PART No.	S=STRAIGHT T=THREAD			BUTT TYPE:		H=HOLLOW S=SOLID		COMMENTS
	MTG. FACE TO POINT OF WELD L	TUBE O.D. & WALL THICKNESS D	TUBE PART No.	BUTT TYPE	BOLT HOLES	MAX. ANGLE		
10-5C-26-376#	75.00 2.950	142.24 x 6.60 5.600 x 0.253		H	T	20	5/8 THREADED HOLES	

INDENT ONLY

www.hardyspicer.com.au

Document No:	HSDSCAT
Issue:	8
Issue Date:	01/07/17

10-5C MECHANICS TYPE



www.hardyspicer.com.au

Document No:	HSDSCAT
Issue:	8
Issue Date:	01/07/17

MECHANICS TYPE 11C

E = 88.90
 3.49
 F = 172.72
 6.78
 C = 40.13
 1.58

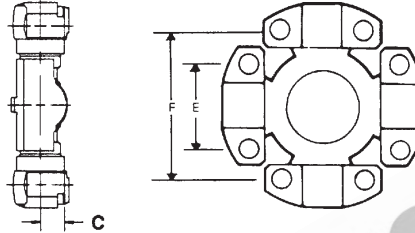

11C MECHANICS TYPE UNIVERSAL JOINT

S = STRAIGHT HOLE		T = THREADED HOLE	C = COUNTERSUNK HOLE
PART No.	LUBE	BEARING CAPS	
114-11002	SIDE	4 X BLOCK (S) (3/4 BOLTS) TWIN DISC J600 SERIES	
114-11002PL	NIL	4 X BLOCK (S) TWIN DISC J600 SERIES	
RUJ-11000	SIDE	4 X BLOCK KOMATSU C=34.04	

Bearing Cap Bolt **15C-73-73405** 12pt 3/4" bolt 3.500" long

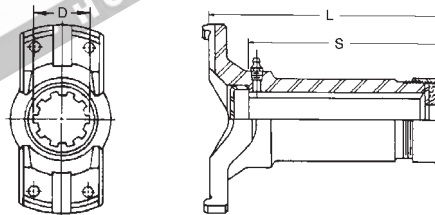

11C SLIP YOKE

PART No.	SPLINE O.D. & No.	MTG. FACE TO END OF SPLINE	LENGTH OF SPLINE	BOLT HOLES	JOINT ANGLE	DUST CAP	COMMENTS
	D	L	S				
11C-3-3340#	101.60-37	336.55	297.18	T	25	DCK15CA	STANDARD
INVOLUTE SPLINE	4.000	13.250	11.700				

End Cap **15C-84099**
 Relief Valve **15C-75395**

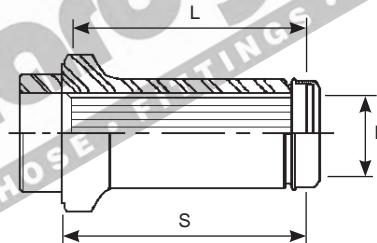

11C SPLINED SLEEVE

PART No.	SPLINE O.D. & No.	WELD POINT TO END OF SPLINE	LENGTH OF SPLINE	TUBE	DUST CAP	COMMENTS
	D	L	S			
15C-55-4037#	101.60-37	250.00	230.00	165-1X9-53MM	DCK15CA*	SPIGOT BUTT $\varnothing = 4.750"$ WELD PREP $\varnothing = 5.775"$
INVOLUTE SPLINE	4.000	9.843	9.055			

* Order Dust Cap Separately

INDENT ONLY

www.hardyspicer.com.au

Document No:	HSDSCAT
Issue:	8
Issue Date:	01/07/17

11C MECHANICS TYPE

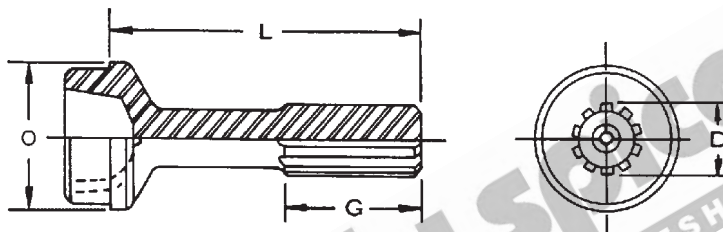

11C STUB

SPLINE TYPE:		HC = HARDY COATED ST = STEEL			BUTT TYPE:		H = HOLLOW S = SOLID		COMMENTS
PART No.	SPLINE DIA. & No. D	SPLINE TYPE	LENGTH OF SPLINE G	END OF SPLINE TO POINT OF WELD L	BUTT TYPE	TUBE O.D. & THICKNESS O	TUBE PART No.		
15C-42-7001 INVOLUTE SPLINE	99-37/38 3.990	HC	165.10 6.500	365.30 14.382	S	165.10 x 9.53 6.500 x 0.375	165-1X9-53MM		
15C-42-6081 INVOLUTE SPLINE	101.60-37 4.000	HC	155.70 6.130	360.43 14.190	S	165.10 x 9.53 6.500 x 0.375	165-1X9-53MM	NO LONGER AVAILABLE	

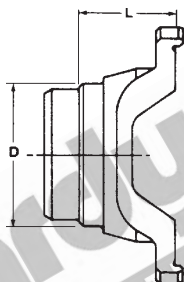

11C WELD YOKE

BOLT HOLES:		S=STRAIGHT T=THREAD		BUTT TYPE:		H=HOLLOW S=SOLID		COMMENTS
PART No.	MTG. FACE TO POINT OF WELD L	TUBE O.D. & WALL THICKNESS D	TUBE PART No.	BUTT TYPE	BOLT HOLES	MAX. ANGLE		
11C-26-377	88.90 3.500	165.10 x 9.53 6.500 x 0.375	165-1X9-53MM	H	T	25		
11C-26-1447	85.00 3.346	144.00 x 7.00 5.669 x 0.275	144X7MM	H	T	25		

Document No:	HSDSCAT
Issue:	8
Issue Date:	01/07/17

MECHANICS TYPE 11C

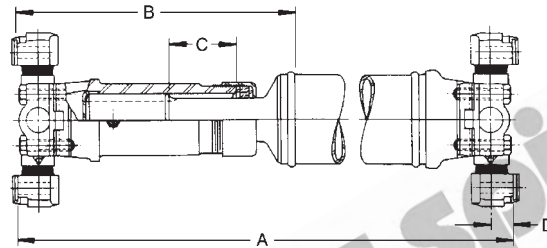

11C TUBULAR TYPE ASSEMBLY CHART

MINIMUM TUBE LENGTH = 75.0mm (2.95")

BOLT HOLES		S=STRAIGHT T=THREADED			C/L TO MTG. FACE		D=40.13mm		
SLIP YOKE FEMALE PART No.	SLIP YOKE BOLT HOLES	STUB MALE PART No.	MTG. FACE TO POINT OF WELD CLOSED	TOTAL SLIP	CLOSED LENGTH MTG. FACE TO MTG. FACE WITH UJ's	WELD YOKE PART No.	WELD YOKE BOLT HOLES	MAX ANGLE OF ASSY.	TUBE PART No. & SIZE
			B	C	A				
11C-3-3340	T	15C-42-7001	439.93 17.370	137.20 5.402	653.41 25.725	11C-26-377	T	25	165.10 x 9.53 6.500 x 0.375

www.hardyspicer.com.au

Document No:	HSDSCAT
Issue:	8
Issue Date:	01/07/17

This catalogue is the copyright of Hardy Spicer

11C MECHANICS TYPE



www.hardyspicer.com.au

Document No:	HSDSCAT
Issue:	8
Issue Date:	01/07/17

MECHANICS TYPE 11C KOMATSU

E = 88.90
 3.49
 F = 172.72
 6.78
 C = 34.00
 1.34

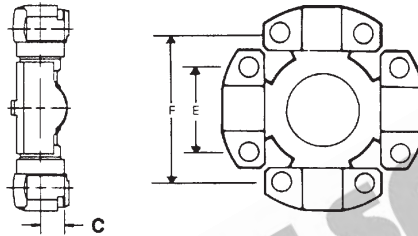

11C MECHANICS TYPE UNIVERSAL JOINT

S = STRAIGHT HOLE		T = THREADED HOLE	C = COUNTERSUNK HOLE
PART No.	LUBE	BEARING CAPS	
RUJ-11000	SIDE	4 X BLOCK KOMATSU	

Bearing Cap Bolt

USE
 11C SERIES
 SLEEVE TYPE
 MATCHING COMPONENTS

www.hardyspicer.com.au

Document No:	HSDSCAT
Issue:	8
Issue Date:	01/07/17

11C KOMATSU MECHANICS TYPE



www.hardyspicer.com.au

Document No:	HSDSCAT
Issue:	8
Issue Date:	01/07/17

MECHANICS TYPE 12C

E = 92.20
 3.62
 F = 241.30
 9.48
 C = 32.51
 1.28

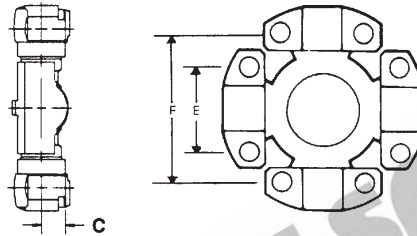

12C MECHANICS TYPE UNIVERSAL JOINT

S = STRAIGHT HOLE		T = THREADED HOLE	C = COUNTERSUNK HOLE
PART No.	LUBE	BEARING CAPS	
114-12002	SIDE	4 X BLOCK (S) (14mm BOLTS <i>Not Supplied</i>) KOMATSU	
114-12002HD	SIDE	PREMIUM 4 X BLOCK (S) (14mm x 1.5 x 80mm BOLTS <i>Supplied</i>) KOMATSU	

Bearing Cap Bolt **12C-73-76956** - M14x2 Hex bolt 80mm long
 Bearing Cap Bolt **12C-73-80344** - M14x1.5 Komatsu bolt 80mm long

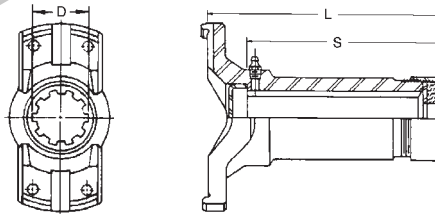

12C SLIP YOKE

PART No.	SPLINE O.D. & No.	MTG. FACE TO END OF SPLINE	LENGTH OF SPLINE	BOLT HOLES	JOINT ANGLE	DUST CAP	COMMENTS
	D	L	S				
12C-3-3350	101.60-37	350.00	275.00	T	25	DCK15CA	AVAIL WHILE STOCKS LAST
INVOLUTE SPLINE	4.000	13.780	10.827				M14x1.5mm THREADED HOLES

End Cap **15C-84099**
 Relief Valve **15C-75395**

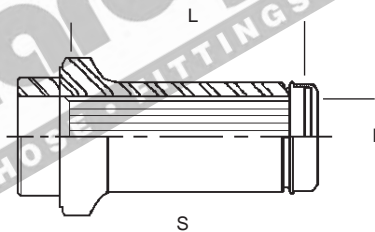

12C SPLINED SLEEVE

PART No.	SPLINE O.D. & No.	WELD POINT TO END OF SPLINE	LENGTH OF SPLINE	TUBE	DUST CAP	COMMENTS
	D	L	S			
15C-55-4037	101.60-37	250.00	230.00	165-1X9-53MM	DCK15CA*	SPIGOT BUTT Ø = 4.750"
INVOLUTE SPLINE	4.000	9.843	9.055			WELD PREP Ø = 5.775"

* Order Dust Cap Separately

www.hardyspicer.com.au

Document No:	HSDSCAT
Issue:	8
Issue Date:	01/07/17

12C MECHANICS TYPE

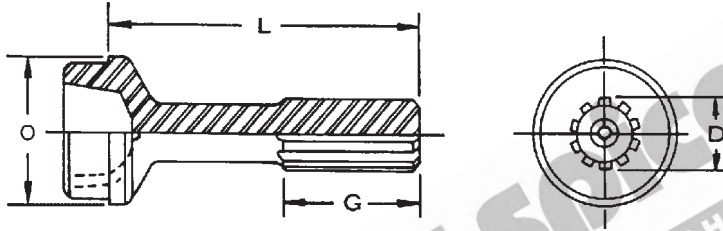

12C STUB

SPLINE TYPE:		HC = HARDY COATED ST = STEEL			BUTT TYPE:		H = HOLLOW S = SOLID		COMMENTS
PART No.	SPLINE DIA. & No. D	SPLINE TYPE	LENGTH OF SPLINE G	END OF SPLINE TO POINT OF WELD L	BUTT TYPE	TUBE O.D. & THICKNESS O	TUBE PART No.		
15C-42-6081 INVOLUTE SPLINE	101.60-37 4.000	HC	155.70 6.130	360.43 14.190	S	165.10 x 9.53 6.500 x 0.375	165-1X9-53MM	NO LONGER AVAILABLE	
15C-42-7001 INVOLUTE SPLINE	100-37/38 3.990	HC	165.10 6.500	365.30 14.382	S	165.10 x 9.53 6.500 x 0.375	165-1X9-53MM	OD FIT SPLINE	

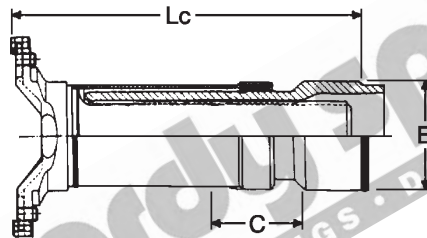

12C SLIP ASSEMBLY

S=STRAIGHT BOLT HOLES				T=THREADED BOLT HOLES			COMMENTS
PART No.	SPLINE O.D. & No. D	MTG. FACE TO WELD POINT Lc	TOTAL SLIP C	TUBE O.D. & WALL THICKNESS	BOLT HOLES	JOINT ANGLE	
12C-83-109 INVOLUTE SPL.	120.00-46 4.724	357.50 14.075	135.00 5.315	160.00 x 10.00 6.299 x 0.394	T	25	

www.hardyspicer.com.au

Document No:	HSDSCAT
Issue:	8
Issue Date:	01/07/17

MECHANICS TYPE 12C

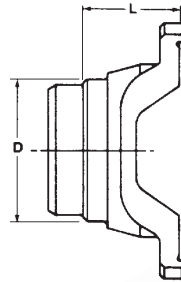

12C

WELD YOKE

BOLT HOLES:		S=STRAIGHT T=THREAD		BUTT TYPE:		H=HOLLOW S=SOLID		COMMENTS
PART No.	MTG. FACE TO POINT OF WELD L	TUBE O.D. & WALL THICKNESS D	TUBE PART No.	BUTT TYPE	BOLT HOLES	MAX. ANGLE		
12C-26-375	101.60 4.000	165.10 x 9.53 6.500 x 0.375	165-1X9-53MM	H	T	25	M14x1.5 THREADED HOLES (KOMATSU) AVAIL WHILE STOCKS LAST	
12C-26-413	64.63 2.544	160.00 x 10.00 6.299 x 0.394	160X10MM	H	T	25	M14x1.5 THREADED HOLES (KOMATSU)	

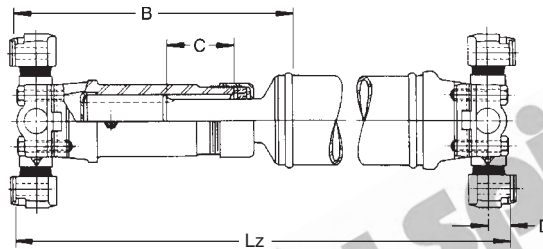

12C

TUBULAR TYPE ASSEMBLY CHART

MINIMUM TUBE LENGTH = 60.0mm (2.36")									
BOLT HOLES		S=STRAIGHT T-THREADED		C/L TO MTG. FACE			D=32.51mm		
SLIP YOKE FEMALE PART No.	SLIP YOKE BOLT HOLES	STUB MALE PART No.	MTG. FACE TO POINT OF WELD CLOSED B	TOTAL SLIP C	CLOSED LENGTH MTG. FACE TO MTG. FACE WITH UJ's Lz	WELD YOKE PART No.	WELD YOKE BOLT HOLES	MAX ANGLE OF ASSY	TUBE PART No. & SIZE
12C-3-3350	T	15C-42-7001	505.00 19.880	125.00 4.920	745.62 29.355	12C-26-375	T	25	165.10 x 9.53 6.500 x 0.375
12C-83-109	T	N/A	422.50 16.634	135.00 5.315	685.00 26.969	12C-26-413	T	25	160.00 x 10.00 6.299 x 0.394

www.hardyspicer.com.au

Document No:	HSDSCAT
Issue:	8
Issue Date:	01/07/17

This catalogue is the copyright of Hardy Spicer

12C MECHANICS TYPE



www.hardyspicer.com.au

Document No:	HSDSCAT
Issue:	8
Issue Date:	01/07/17

MECHANICS TYPE 12-5C

E = 92.00
 3.62
 F = 227.00
 8.97
 C = 38.00
 1.50

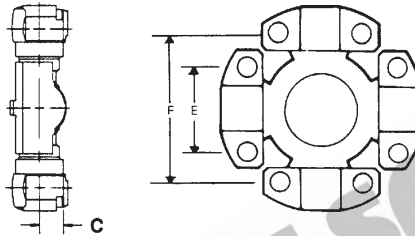

12-5C MECHANICS TYPE UNIVERSAL JOINT

S = STRAIGHT HOLE		T = THREADED HOLE	C = COUNTERSUNK HOLE
PART No.	LUBE	BEARING CAPS	
RUJ-12500	SIDE	4 X BLOCK (S) TEREX	

COMPONENT PARTS
 AVAILABLE ON REQUEST

www.hardyspicer.com.au

Document No:	HSDSCAT
Issue:	8
Issue Date:	01/07/17

12-5C MECHANICS TYPE



www.hardyspicer.com.au

Document No:	HSDSCAT
Issue:	8
Issue Date:	01/07/17

MECHANICS TYPE 14C

E = 135.00
 5.315
 F = 270.00
 10.630
 C = 49.00
 1.929

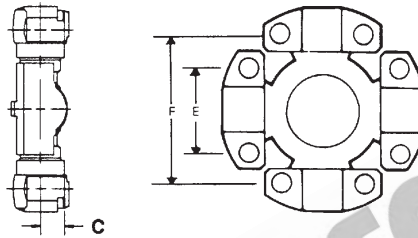

14C MECHANICS TYPE UNIVERSAL JOINT

S = STRAIGHT HOLE		T = THREADED HOLE	C = COUNTERSUNK HOLE
PART No.	LUBE	BEARING CAPS	
<i>RUJ-14001</i>	SIDE	4 X BLOCK (S) KOMATSU 14C	

Bearing Cap Bolt **KOM-73-81493** - M18x1.5 Komatsu bolt

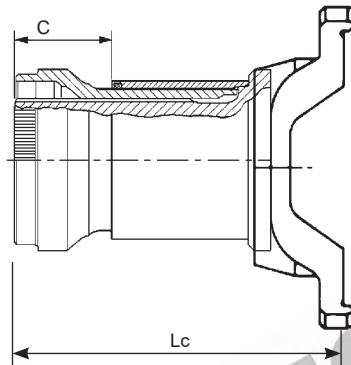

14C SLIP ASSEMBLY

S=STRAIGHT BOLT HOLES				T=THREADED BOLT HOLES			
PART No.	SPLINE O.D. & No.	MTG. FACE TO WELD POINT Lc	TOTAL SLIP C	TUBE O.D. & WALL THICKNESS	BOLT HOLES	JOINT ANGLE	COMMENTS
<i>KOM-83-108</i>	150.00-48 5.906	370.00 14.567	135.00 5.315	219.00 x 13.30 8.622 x 0.524	T	25	THREADED HOLES M18 x 1.5mm

www.hardyspicer.com.au

Document No:	HSDSCAT
Issue:	8
Issue Date:	01/07/17

This catalogue is the copyright of Hardy Spicer

14C MECHANICS TYPE

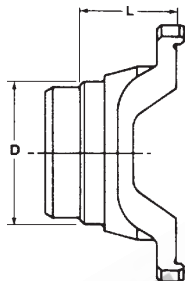

14C WELD YOKE

BOLT HOLES:		S=STRAIGHT T=THREAD		BUTT TYPE:			H=HOLLOW S=SOLID	
PART No.	MTG. FACE TO POINT OF WELD L	TUBE O.D. & WALL THICKNESS D	TUBE PART No.	BUTT TYPE	BOLT HOLES	MAX. ANGLE	COMMENTS	
KOM-26-410	100.00 3.937	219.00 x 13.30 8.622 x 0.524	219X13-3MM	H	T	25	SUIT KOMATSU	

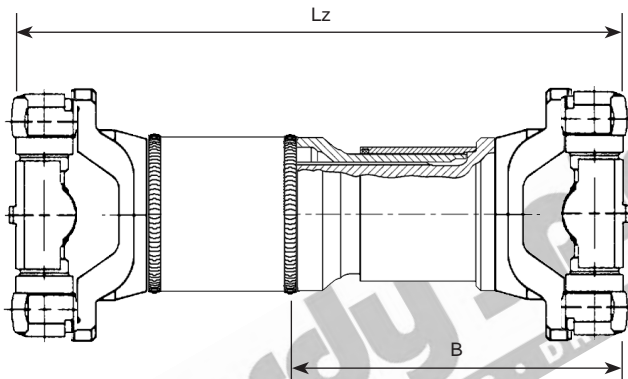

14C TUBULAR TYPE ASSEMBLY CHART

MINIMUM TUBE LENGTH =									
BOLT HOLES		S=STRAIGHT T=THREADED			C/L TO MTG. FACE			D=49.00mm	
SLIP YOKE FEMALE PART No.	SLIP YOKE BOLT HOLES	STUB MALE PART No.	MTG. FACE TO POINT OF WELD CLOSED B	TOTAL SLIP	CLOSED LENGTH MTG. FACE TO MTG. FACE WITH UJ's Lz	WELD YOKE PART No.	WELD YOKE BOLT HOLES	MAX ANGLE OF ASSY	TUBE PART No. & SIZE
KOM-83-108	T	N/A	468.00 18.425	135.00 5.315	738.00 29.055	KOM-26-410	T	25	219.00 x 13.30 8.622 x 0.524

www.hardyspicer.com.au

Document No:	HSDSCAT
Issue:	8
Issue Date:	01/07/17

MECHANICS TYPE 14C

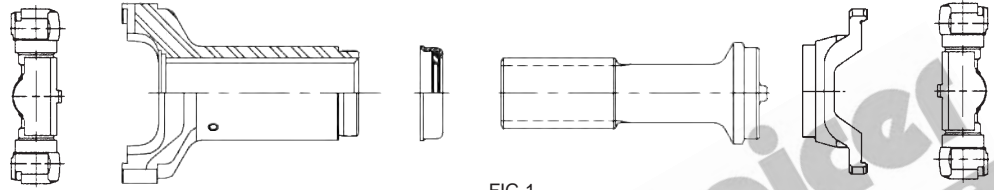

FIG 1

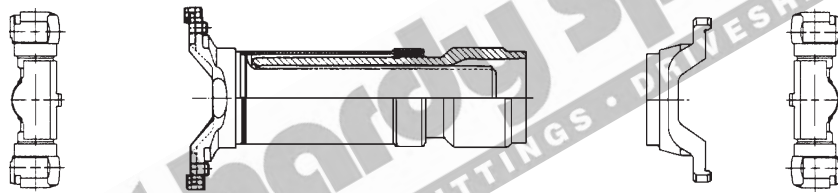

FIG 2

14C

PSA KITS

KIT PART No.	UNIVERSAL JOINTS	SLIP ASSEMBLY	WELD YOKE	TUBE TO SUIT (NOT INCL.)	COMMENTS
	1	2	3		
KOM-PSA-KIT (FIG 2)	RUJ-14001 (2 off)	KOM-83-108	KOM-26-410	219X13-3MM	Standard kit (Cover Sleeve type splines)

www.hardyspicer.com.au

Document No:	HSDSCAT
Issue:	8
Issue Date:	01/07/17

This catalogue is the copyright of Hardy Spicer

14C MECHANICS TYPE



www.hardyspicer.com.au

Document No:	HSDSCAT
Issue:	8
Issue Date:	01/07/17

MECHANICS TYPE 14-5C

E = 107.00
 4.213
 F = 252.00
 9.921
 C = 44.00
 1.73

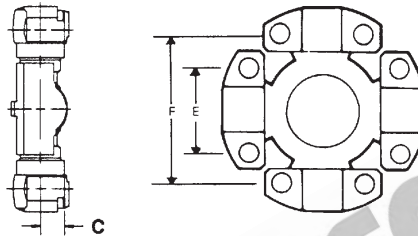

14-5C MECHANICS TYPE UNIVERSAL JOINT

S = STRAIGHT HOLE		T = THREADED HOLE	C = COUNTERSUNK HOLE
PART No.	LUBE	BEARING CAPS	
RUJ-14500	SIDE	4 X BLOCK (S) CATERPILLAR 14-5C	

Bearing Cap Bolt **14-5C-73-20004** - M22x1.5

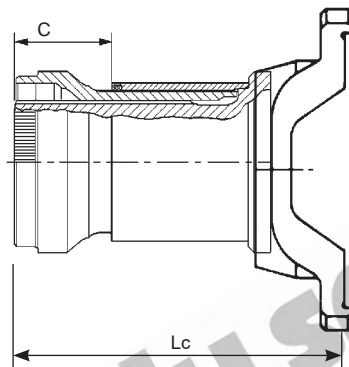

14-5C SLIP ASSEMBLY

S=STRAIGHT BOLT HOLES			T=THREADED BOLT HOLES				COMMENTS
PART No.	SPLINE O.D. & No.	MTG. FACE TO WELD POINT Lc	TOTAL SLIP C	TUBE O.D. & WALL THICKNESS	BOLT HOLES	JOINT ANGLE	
14-5C-83-110	150.00-48	370.00	135.00	219.00 x 13.30 8.622 x 0.524	T	25	THREADED HOLES M22 x 1.5

www.hardyspicer.com.au

Document No:	HSDSCAT
Issue:	8
Issue Date:	01/07/17

This catalogue is the copyright of Hardy Spicer

14-5C MECHANICS TYPE

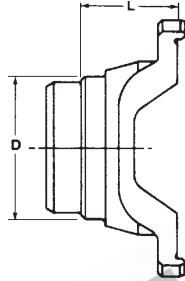

14-5C WELD YOKE

BOLT HOLES:		S=STRAIGHT T=THREAD	BUTT TYPE:			H=HOLLOW S=SOLID	COMMENTS
PART No.	MTG. FACE TO POINT OF WELD L	TUBE O.D. & WALL THICKNESS D	TUBE PART No.	BUTT TYPE	BOLT HOLES	MAX. ANGLE	
14-5C-26-219	100.00 3.937	219.00 x 13.30 8.622 x 0.524	219X13-3MM	H	T	25	THREADED HOLES M22 x 1.5

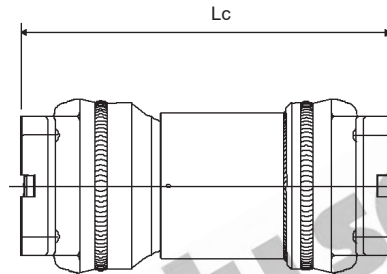

14-5C SHORT COUPLED SLIP ASSEMBLY

S=STRAIGHT BOLT HOLES				T=THREADED BOLT HOLES			
PART No.	SPLINE O.D. & No.	MTG. FACE TO MTG. FACE COMPRESSED Lc	TOTAL SLIP	REPLACEMENT SPLINES	BOLT HOLES	JOINT ANGLE	COMMENTS
14-5C-83-464#	150.00-48 5.906	464.00 18.268	135.00 5.315	6-390-651180281	T	25	THREADED HOLES M22 x 1.5

INDENT ITEM

www.hardyspicer.com.au

Document No:	HSDSCAT
Issue:	8
Issue Date:	01/07/17

MECHANICS TYPE 14-5C

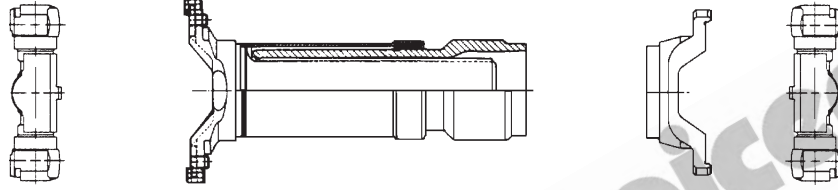

14-5C

PSA KITS

KIT PART No.	UNIVERSAL JOINTS	SLIP ASSEMBLY	WELD YOKE	TUBE TO SUIT (NOT INCL.)	COMMENTS
	1	2	3		
14-5C-PSA-KIT	RUJ-14500 (2 off)	14-5C-83-110	14-5C-26-219	219X13-3MM	Standard kit (Cover Sleeve type splines) AVAILABLE WHILE STOCKS LAST

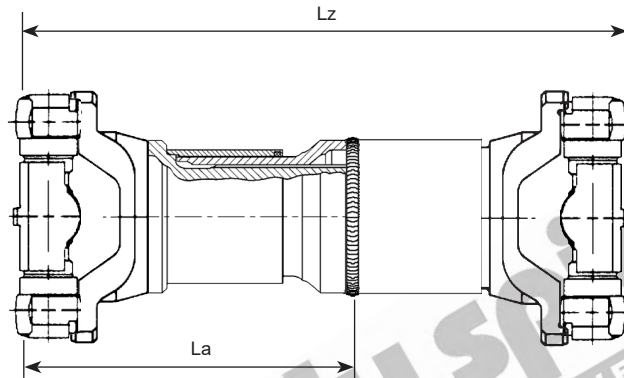

14-5C

UNWELDED SHAFT

KIT PART No.	UNIVERSAL JOINTS	SLIP ASSEMBLY	WELD YOKE (UNWELDED)	TUBE	LENGTH M/F - M/F (CLOSED) Lz	TOTAL SLIP La
14-5C-PSA-1800	RUJ-14500	14-5C-83-110	14-5C-26-219	219X13-3MM	1800mm	135mm

www.hardyspicer.com.au

Document No:	HSDSCAT
Issue:	8
Issue Date:	01/07/17

This catalogue is the copyright of Hardy Spicer

14-5C MECHANICS TYPE



www.hardyspicer.com.au

Document No:	HSDSCAT
Issue:	8
Issue Date:	01/07/17

MECHANICS TYPE 15C

E = 99.97
 3.93
 F = 199.95
 7.85
 C = 38.10
 1.50

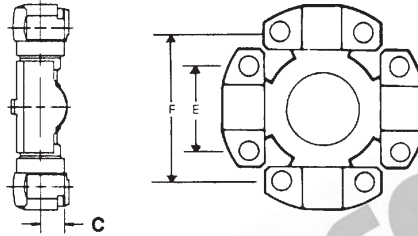

15C MECHANICS TYPE UNIVERSAL JOINT

S = STRAIGHT HOLE		T = THREADED HOLE	C = COUNTERSUNK HOLE
PART No.	LUBE	BEARING CAPS	
114-15002R	SIDE	4 X BLOCK (S) MECHANICS 15C / TWIN DISC J800 SERIES	
114-15002W	SIDE	4 X BLOCK (S) MECHANICS 15C / TWIN DISC J800 SERIES	
114-15002PL	NIL	PREMIUM PERMANENT LUBE 4 X BLOCK (S) MECHANICS 15C / TWIN DISC J800 SERIES	
114-15003R#	SIDE	4 X BLOCK (S) MECHANICS 15C / TWIN DISC J800 SERIES - METRIC BOLTS	
114-15003PL#	NIL	PREMIUM PERMANENT LUBE 4 X BLOCK (S) TWIN DISC J800 SERIES - METRIC BOLTS	

Bearing Cap Bolt **15C-73-73405** - 12 PT 3/4" bolt 3.500" long
 Bearing Cap Bolt **15C-73-76818** - 12 PT M20x2.5 bolt 90mm long

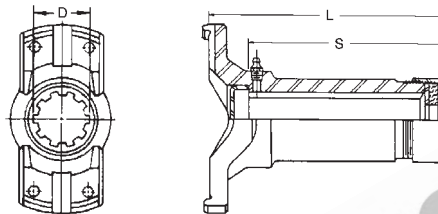

15C SLIP YOKE

PART No.	SPLINE O.D. & No.	MTG. FACE TO END OF SPLINE	LENGTH OF SPLINE	BOLT HOLES	JOINT ANGLE	COMMENTS
	D	L	S			
15C-3-3580	99-37/38	349.30	273.10	T	25	STANDARD 3/4" UNF THREADED HOLES
INVOLUTE SPLINE	3.990	13.752	10.750			OD FIT SPLINES
15C-3-3590	99-37/38	349.30	273.10	T	25	M20 METRIC THREADED HOLES
INVOLUTE SPLINE	3.990	13.752	10.750			OD FIT SPLINES

Dust Cap Kit **DCK15CA**
 End Cap **15C-84099**
 Relief Valve **15C-75395**

www.hardyspicer.com.au

Document No:	HSDSCAT
Issue:	8
Issue Date:	01/07/17

This catalogue is the copyright
 of Hardy Spicer

15C MECHANICS TYPE

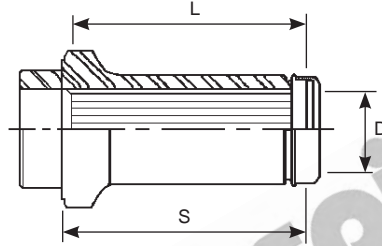

15C SPLINED SLEEVE

PART No.	SPLINE O.D. & No. D	WELD POINT TO END OF SPLINE L	LENGTH OF SPLINE S	TUBE 165-1X9-53MM	DUST CAP DCK15CA*	COMMENTS
15C-55-4037 INVOLUTE SPLINE	101.60-37 4.000	250.00 9.843	230.00 9.055			SPIGOT BUTT $\varnothing = 4.750"$ WELD PREP $\varnothing = 5.775"$

* Order Dust Cap Separately

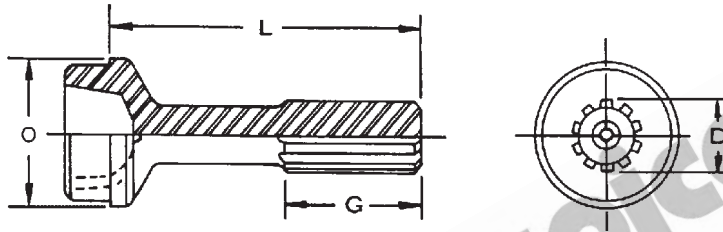

15C STUB

SPLINE TYPE:		HC = HARDY COATED ST = STEEL			BUTT TYPE:		H = HOLLOW S = SOLID		COMMENTS
PART No.	SPLINE DIA. & No. D	SPLINE TYPE	LENGTH OF SPLINE G	END OF SPLINE TO POINT OF WELD L	BUTT TYPE	TUBE O.D. & THICKNESS O	TUBE PART No.		
15C-42-6081 INVOLUTE SPLINE	101.60-37 4.000	HC	155.70 6.130	360.43 14.190	S	165.10 x 9.53 6.500 x 0.375	165-1X9-53MM	NO LONGER AVAILABLE	
15C-42-7001 INVOLUTE SPLINE	99-37/38 3.990	HC	165.10 6.500	365.30 14.382	S	165.10 x 9.53 6.500 x 0.375	165-1X9-53MM	OD FIT SPLINE	

www.hardyspicer.com.au

Document No:	HSDSCAT
Issue:	8
Issue Date:	01/07/17

MECHANICS TYPE 15C

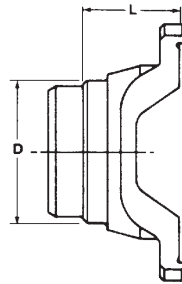

15C

WELD YOKE

BOLT HOLES:		S=STRAIGHT T=THREAD		BUTT TYPE:		H=HOLLOW S=SOLID		COMMENTS
PART No.	MTG. FACE TO POINT OF WELD L	TUBE O.D. & WALL THICKNESS D	TUBE PART No.	BUTT TYPE	BOLT HOLES	MAX. ANGLE		
15C-26-378	101.60 4.000	165.10 x 6.35 6.500 x 0.250	165-1X6-35MM	H	T	25	WHILE STOCKS LAST	
15C-26-394	101.60 4.000	165.10 x 9.53 6.500 x 0.375	165-1X9-53MM	H	T	25	STANDARD	
15C-26-414#	101.60 4.000	165.10 x 9.53 6.500 x 0.375	165-1X9-53MM	H	T	25	M20x2.5mm THREADED HOLES	

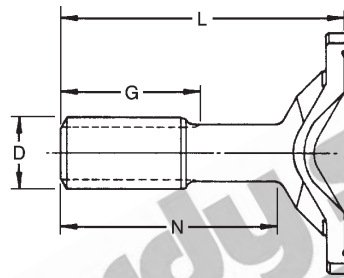

15C

STUB YOKE

SPLINE TYPE:		HC = HARDY COATED ST = STEEL			BUTT TYPE:		H = HOLLOW S = SOLID		COMMENTS
PART No.	SPLINE DIA. & No. D	LENGTH OF SPLINE G	MTG. FACE TO END OF SPLINE L	SHOULDER TO END OF SPLINE N	BOLT HOLES	SPLINE TYPE	MAX. ANGLE		
15C-82-8711# INVOLUTE SPL	101.60-37 4.000	101.60 4.000	339.85 13.380		T METRIC	INV		SUITS 15C-3-3550 (NLA)	

www.hardyspicer.com.au

Document No:	HSDSCAT
Issue:	8
Issue Date:	01/07/17

This catalogue is the copyright of Hardy Spicer

15C MECHANICS TYPE

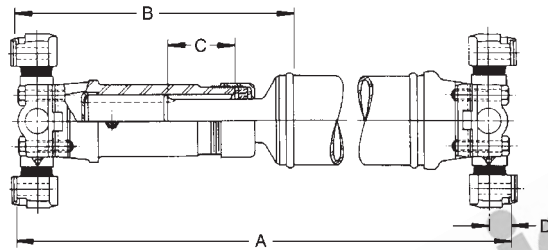

15C TUBULAR TYPE ASSEMBLY CHART

MINIMUM TUBE LENGTH = 137.3mm (5.40")

BOLT HOLES		S=STRAIGHT T=THREADED		C/L TO MTG. FACE			D=38.10mm		
SLIP YOKE FEMALE PART No.	SLIP YOKE BOLT HOLES	STUB MALE PART No.	MTG. FACE TO POINT OF WELD CLOSED	TOTAL SLIP	CLOSED LENGTH MTG. FACE TO MTG. FACE WITH UJ's	WELD YOKE PART No.	WELD YOKE BOLT HOLES	MAX ANGLE OF ASSY.	TUBE PART No. & SIZE
			B	C	A				
15C-3-3380	T	15C-42-7001	497.00	127.00	814.00	15C-26-394	T	25	165.10 x 9.53 6.500 x 0.375
15C-3-3590 (METRIC BOLTS)	T	15C-42-7001	497.00	127.00	814.00	15C-26-414	T	25	165.10 x 9.53 6.500 x 0.375
			19.567	5.000	32.047				

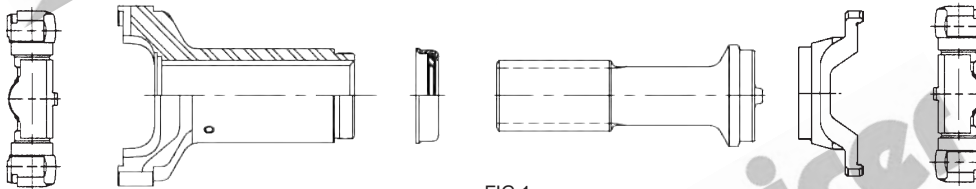

FIG 1

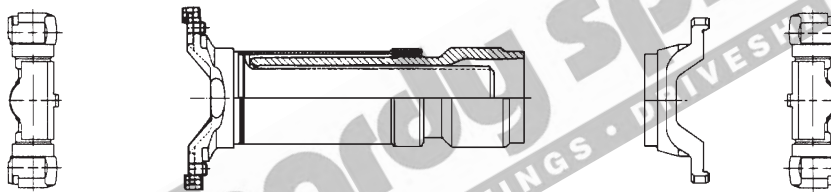

FIG 2

15C PSA KITS

KIT PART No.	UNIVERSAL JOINTS	SLIP ASSEMBLY	WELD YOKE	TUBE TO SUIT (NOT INCL.)	COMMENTS
	1	2	3		
15C-PSA-KIT (FIG 1)	114-15002R (2 off)	15C-3-3380 15C-42-7001	15C-26-394	165-1X9-53MM	Standard kit (Slip / Stub type splines)
15C-PSA-KIT-M# (FIG 1)	114-15003R (2 off)	15C-3-3590 15C-42-7001	15C-26-414	165-1X9-53MM	Metric threads (Slip / Stub type splines)
J800-PSA-KIT-A# (FIG 2)	114-15002PL (NOT INCL.)			165-1X8-64MM	Machine butts to suit 165.1 x 9.53mm (Cover Sleeve type splines)

www.hardyspicer.com.au

Document No:	HSDSCAT
Issue:	8
Issue Date:	01/07/17

INDENT ITEM

B:3-84

MECHANICS TYPE 15C

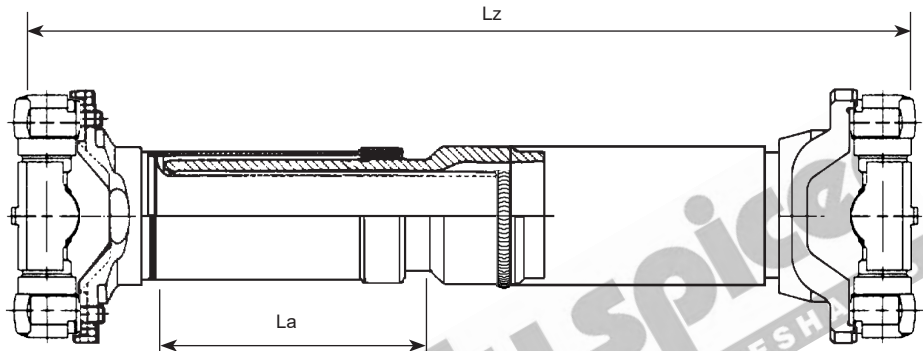

15C

UNWELDED SHAFT

KIT PART No.	UNIVERSAL JOINTS	SLIP ASSEMBLY	WELD YOKE (UNWELDED)	TUBE	LENGTH M/F - M/F (CLOSED) Lz	TOTAL SLIP La
15C-PSA-1800	114-15002PL			165-1X12-7MM	1800mm	130mm

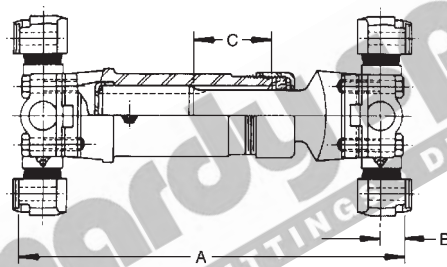

15C

SHORT COUPLED ASSEMBLY CHART

SLIP YOKE FEMALE PART No.	SLIP YOKE BOLT HOLES	STUB YOKE MALE PART No.	BOLT HOLES S=STRAIGHT T=THREADED	SPLINE SIZE & No.	TOTAL SLIP C	CLOSED LENGTH MTG. FACE TO MTG. FACE (INCL. UJ's) A	MAX. ANGLE OF ASSY.	C/L TO MTG. FACE UJ's B
15C-3-3550#	T	15C-82-8711#	T	101.60-37 4.000	80.00 3.150	567.40 22.339		38.10 1.500

www.hardyspicer.com.au

Document No:	HSDSCAT
Issue:	8
Issue Date:	01/07/17

This catalogue is the copyright of Hardy Spicer

15C MECHANICS TYPE

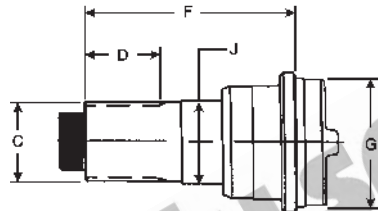

15C MIDSHIP STUB

PART No.	SPLINE O.D. & No.	LENGTH OF SPLINE	END OF SPLINE TO POINT OF WELD	TUBE PART No. & SIZE	BEARING DIAMETER	COMMENTS
	C	D	F	G	J	
15C-53-1500	16/32-57 INVOLUTE	100.30 3.949	284.20 11.189	165-1X9-53MM	100.00 3.937	
15C-53-1501#	16/32-57 INVOLUTE	102.40 4.031	284.00 11.181	165-1X9-53MM	97.00 3.819	

www.hardyspicer.com.au

Document No:	HSDSCAT
Issue:	8
Issue Date:	01/07/17

MECHANICS TYPE 15-5C

E = 99.97
 3.93
 F = 199.95
 7.85
 C = 38.10
 1.50

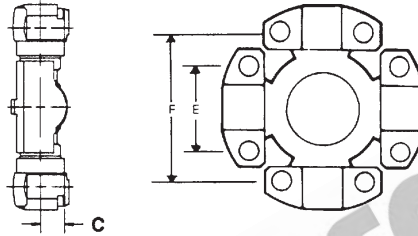

15-5C MECHANICS TYPE UNIVERSAL JOINT

S = STRAIGHT HOLE		T = THREADED HOLE	C = COUNTERSUNK HOLE
PART No.	LUBE	BEARING CAPS	
114-15500PL	NIL	PREMIUM PERMANENT LUBE 4 X BLOCK (S) MECHANICS 15-5C	

USE
 15C SERIES
 SLEEVE TYPE
 MATCHING COMPONENTS

www.hardyspicer.com.au

Document No:	HSDSCAT
Issue:	8
Issue Date:	01/07/17

15-5C MECHANICS TYPE



www.hardyspicer.com.au

Document No:	HSDSCAT
Issue:	8
Issue Date:	01/07/17

MECHANICS TYPE 20C

E = 117.60
4.63
F = 277.10
10.91
C = 48.40
1.91

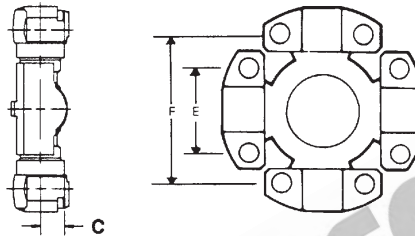

15C MECHANICS TYPE UNIVERSAL JOINT

S = STRAIGHT HOLE		T = THREADED HOLE	C = COUNTERSUNK HOLE
PART No.	LUBE	BEARING CAPS	
114-20000PL	NIL	PREMIUM PERMANENT LUBE 4 X BLOCK (S) MECHANICS 20C	

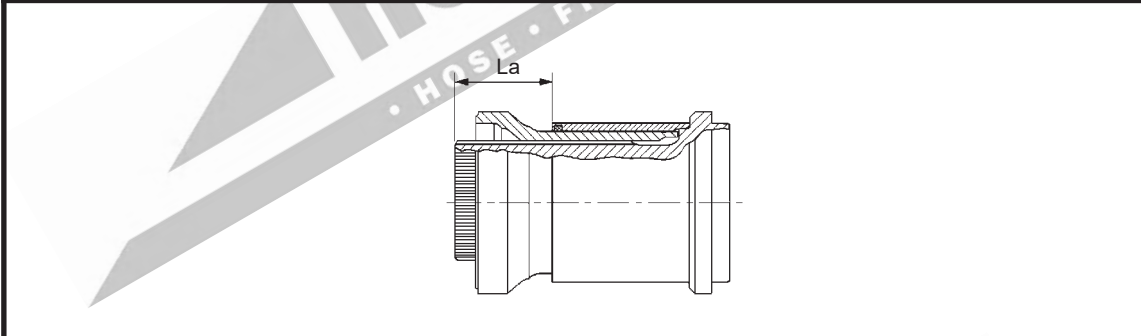

20C SPLINED SLEEVE ASSY

SHAFT PART No.	POINT OF WELD TO POINT OF WELD CLOSED	TOTAL SLIP La	BUTT DIAMETER	COMMENTS
20C-83-1503	270.00 10.630	135.00 5.315	200.80 7.906	BOTH MALE AND FEMALE BUTTS ARE SAME DIAMETER

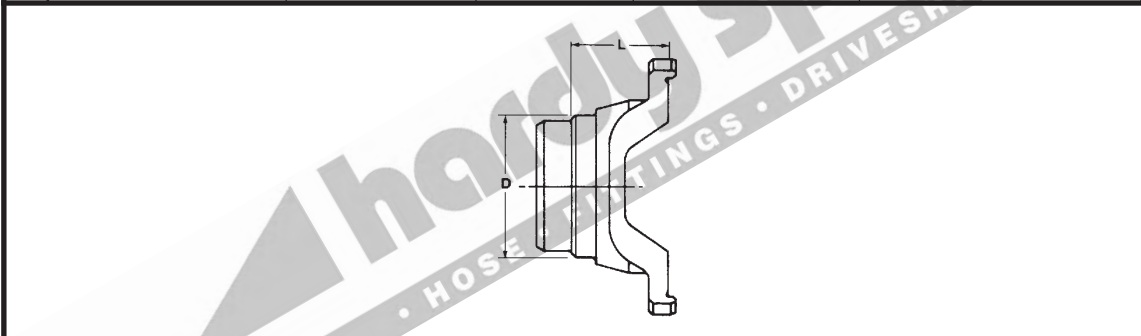

20C WELD YOKE

BOLT HOLES:		S=STRAIGHT T=THREAD		BUTT TYPE:			H=HOLLOW S=SOLID	COMMENTS
PART No.	MTG. FACE TO POINT OF WELD L	TUBE O.D. & WALL THICKNESS D	TUBE PART No.	BUTT TYPE	BOLT HOLES	MAX. ANGLE		
20C-26-416	139.70 5.500	203.20 x 12.70 8.000 x .500		H	T		THREADED HOLES M24 x 3	

www.hardyspicer.com.au

Document No:	HSDSCAT
Issue:	8
Issue Date:	01/07/17

DRIVE TUBE HARDY SPICER

Part Number	Size	Description	Butt Size (inch - mm)	
1216-0000	1.50 x .065	DRIVE TUBE - 1.50x.065"	1.380"	35.05mm
1416-0000	1.75 x .065	DRIVE TUBE - 1.75x.065"	1.628"	41.35mm
1616-0000	2.00 x .065	DRIVE TUBE - 2.00x.065"	1.880"	47.75mm
1613-0000	2.00 x .095	DRIVE TUBE - 2.00x.095"	1.817"	46.15mm
1711-0000	2.125" x .120	DRIVE TUBE - 2.125x.120"	1.892"	48.05mm
1816-0000	2.25 x .065	DRIVE TUBE - 2.25x.065"	2.130"	54.10mm
1813-0000	2.25 x .095	DRIVE TUBE - 2.25x.095"	2.070"	52.58mm
2016-0000	2.50 x .065	DRIVE TUBE - 2.50x.065"	2.380"	60.45mm
2014-0000	2.50 x .083	DRIVE TUBE - 2.50x.083"	2.340"	59.44mm
2013-0000	2.50 x .095	DRIVE TUBE - 2.50x.095"	2.317"	58.85mm
2011-0000	2.50 x .120	DRIVE TUBE - 2.50x.120"	2.267"	57.58mm
2216-0000	2.75 x .065	DRIVE TUBE - 2.75x.065"	2.632"	66.85mm
2214-0000	2.75 x .083	DRIVE TUBE - 2.75x.083"	2.591"	65.81mm
2213-0000	2.75 x .095	DRIVE TUBE - 2.75x.095"	2.570"	65.28mm
2416-0000	3.00 x .065	DRIVE TUBE - 3.00x.065"	2.880"	73.15mm
2414-0000	3.00 x .083	DRIVE TUBE - 3.00x.083"	2.840"	72.14mm
2413-0000	3.00 x .095	DRIVE TUBE - 3.00x.095"	2.817"	71.55mm
2615-0000	3.25 x .065	DRIVE TUBE - 3.25x.065"	3.130"	79.50mm
2611-0000	3.25 x .125	DRIVE TUBE - 3.25x.125"	3.007"	76.38mm
2816-0000	3.50 x .065	DRIVE TUBE - 3.50x.065"	3.380"	85.85mm
2814-0000	3.50 x .083	DRIVE TUBE - 3.50x.083"	3.340"	84.84mm
2813-0000	3.50 x .095	DRIVE TUBE - 3.50x.095"	3.320"	84.33mm
2810-0000	3.50 x .134	DRIVE TUBE - 3.50x.134"	3.240"	82.30mm
3214-0000	4.00 x .083	DRIVE TUBE - 4.00x.083"	3.840"	97.54mm
3213-0000	4.00 x .095	DRIVE TUBE - 4.00x.095"	3.820"	97.03mm
3210-0000	4.00 x .134	DRIVE TUBE - 4.00x.134"	3.745"	95.12mm
3207-0000	4.09 x .180	DRIVE TUBE - 4.09x.180"	3.745"	95.12mm
3613-0000	4.50 x .095	DRIVE TUBE - 4.50x.095"	4.320"	109.73mm
3610-0000	4.50 x .134	DRIVE TUBE - 4.50x.134"	4.242"	107.75mm
3607-0000	4.59 x .180	DRIVE TUBE - 4.59x.180"	4.242"	107.75mm
3603-0000	4.50 x .259	DRIVE TUBE - 4.50x.259"	4.000"	101.60mm
2013-0000CM	2.5 x .095 (4130)	2.5 x 0.095" C/M 4130 TUBE	2.317"	58.85mm
2414-0000CM	3.00 x .083 (4130)	DRIVE TUBE - 3.00x.083" CR/MO	2.840"	72.14mm
2413-0000CM	3.00 x .095 (4130)	DRIVE TUBE - 3.00x.095" CR/MO	2.817"	71.55mm
35-60CM	3.50 x .083 (4130)	3.50x.083" CR/MO (60" LONG)	3.340"	84.84mm
35-72A	3.50 x .125 (ALI)	6061-T6 ALUM TUBE 3.5X.125X72I	3.257"	82.73mm
28X1-1/2MM	28 x 1.5mm	DRIVE TUBE - 473.10 SERIES	0.992"	25.20mm
36X1-1/2MM	36 x 1.5mm	DRIVE TUBE - 473.20 SERIES	1.307"	33.20mm
50X2MM	50 x 2mm	DRIVE TUBE - 287.00 SERIES	1.819"	46.20mm
50X3MM	50 x 3mm	DRIVE TUBE - 287.10 SERIES	1.740"	44.20mm
60X4MM	60 x 4mm	DRIVE TUBE - CV15 ELBE 112	2.055"	52.20mm
60X5MM	60 x 5mm	DRIVE TUBE - 60mm x 5mm	1.976"	50.20mm
70X3MM	70 x 3mm	DRIVE TUBE - 287.20/587.10	2.528"	64.20mm

www.hardyspicer.com.au

Document No:	HSDSCAT
Issue:	8
Issue Date:	01/07/17

HARDY SPICER DRIVE TUBE				
Part Number	Size	Description	Butt Size (inch - mm)	
65X1-6MM	65 x 1.6mm	DRIVE TUBE - 65mm x 1.6mm	2.441"	62.00mm
70X4MM	70 x 4mm	DRIVE TUBE - 6C,CV21/30 SERIES	2.449"	62.20mm
73X4MM	73 x 4mm	DRIVE TUBE - 73 x 4 MM	2.567"	65.20mm
80X3-1/2MM	80 x 3.5mm	DRIVE TUBE - 587.15 SERIES	2.882"	73.20mm
80X4MM	80 x 4mm	DRIVE TUBE - ELBE 148 7C	2.843"	72.20mm
85X5MM	85 x 5mm	DRIVE TUBE - 587.20 SERIES	2.961"	75.20mm
88X4MM	88 x 4mm	DRIVE TUBE - METRIC 7C SERIES	3.157"	80.20mm
90X3MM	90 x 3mm	DRIVE TUBE - 687.30 SERIES	3.315"	84.20mm
90X4-1/2MM	90 x 4.5mm	DRIVE TUBE - 90 x 4.5mm	3.197"	81.20mm
90X4MM	90 x 4mm	DRIVE TUBE - M.BENZ/ISUZU/HINO	3.236"	82.20mm
90X5-1/2MM	90 x 5.5mm	USE 92X6-1/2MM	3.512"	79.20mm
90X6MM	90 x 6mm	DRIVE TUBE - 400 VOLVO ALT.	3.472"	78.20mm
92X6-1/2MM	92 x 6.5mm	DRIVE TUBE - 587.30 SERIES	3.512"	79.20mm
100X3MM	100 x 3mm	DRIVE TUBE - 687.35 SERIES	3.709"	94.20mm
100X4MM	100 x 4mm	DRIVE TUBE - 100x4mm	3.630"	92.20mm
100X4-1/2MM	100 x 4.5mm	DRIVE TUBE - 100x4.5mm	3.591"	91.20mm
100X5MM	100 x 5mm	DRIVE TUBE - ELBE 117MERCEDES	3.551"	90.20mm
100X6MM	100 x 6mm	DRIVE TUBE - 587.35 SERIES	3.472"	88.20mm
110X6MM	110 x 6mm	DRIVE TUBE - 110x6mm	3.866"	98.20mm
111-1/2X6-3/4MM	111.5 x 6.75mm	DRIVE TUBE - 587.42 SERIES	3.866"	98.20mm
114-3X9-53MM	114.3 x 9.53mm	DRIVE TUBE - 9C SERIES	3.757"	95.44MM
115X7-1/2MM	115 x 7.5mm	DRIVE TUBE - METRIC 9C SERIES	3.945"	100.20mm
120X3MM	120 x 3mm	DRIVE TUBE - 687.40 SERIES	4.496"	114.20mm
120X4MM	120 x 4mm	DRIVE TUBE - 687.45 SERIES	4.417"	112.20mm
120X6MM	120 x 6mm	DRIVE TUBE - 687.55 SERIES	4.260"	108.20mm
123-1/2X8MM	123.5 x 8mm	DRIVE TUBE - OLD 587.50/190.50	4.240"	107.70mm
127X6-35MM	127 x 6.35mm	DRIVE TUBE - 10C/10.5C SERIES	4.508"	114.50mm
127X9-53MM	127 x 9.53mm	DRIVE TUBE - 10C/10.5C SERIES	4.257"	108.14mm
130X6MM	130 x 6mm	DRIVE TUBE - 687.60 SERIES	4.654"	118.20mm
132X6MM	132 x 6mm	SPL250 HEAVY TUBING	4.732"	120.20mm
140X5MM	140 x 5mm	DRIVE TUBE - 587.48/10C SERIES	5.126"	130.20mm
142X6MM	142 x 6mm	DRIVE TUBE - 687.65/10C SERIES	5.126"	130.20mm
144X7MM	144 x 7mm	DRIVE TUBE - 587.50/10C SERIES	5.126"	130.20mm
160X10MM	160 x 10mm	DRIVE TUBE - 12C/15C EURO	5.520"	140.20mm
162X9-85MM	162 x 9.85mm	DRIVE TUBE - 162 x 9.85mm	5.610"	142.50mm
165-1X12-7MM	165.1 x 12.7mm	DRIVE TUBE - 15C HEAVY DUTY	5.508"	139.90mm
165-1X7-01MM	165.1 x 7.01mm	DRIVE TUBE - J600 SERIES	5.956"	151.28mm
165-1X8-64MM	165.1 x 8.64mm	DRIVE TUBE - J800 SERIES	5.828"	148.02mm
165-1X9-53MM	165.1 x 9.53mm	DRIVE TUBE - 11C/12C/15C SERIES	5.757"	146.24mm
167-7X9-8MM	167.7 x 9.8mm	DRIVE TUBE - 390.60 SERIES	5.839"	148.30mm
168-8X7-3MM	168.8 x 7.3mm	DRIVE TUBE - 587.55 SERIES	6.079"	154.40mm
218-2X8-7MM	218.2 x 8.7mm	DRIVE TUBE - 390.65 SERIES	7.913"	201.00mm
219X13-3MM	219 x 13.3mm	DRIVE TUBE - 390.70/14C SERIES	7.583"	192.60mm

www.hardyspicer.com.au

Document No:	HSDSCAT
Issue:	8
Issue Date:	01/07/17

BOLTS HARDY SPICER



BEARING CAP BOLTS

HARDY SPICER PART NO.	BOLT SIZE	TYPE	COMMENTS
9C-73-76619	1/2" UNF x 2.250"	12 POINT BOLT	8-5C & 9C
9C-73-84971	M12 x 1.75 x 60mm	12 POINT BOLT	8-5C & 9C
9-5C-73-74569	1/2" UNF x 2.500"	12 POINT BOLT	9-5C
10C-73-72424	5/8" UNF x 3.250"	12 POINT BOLT	10C
10C-73-74613	M16 x 2.0 x 80mm	HEX HEAD BOLT	10C
12C-73-80344	M14 x 1.5 x 80mm	HEX HEAD BOLT	12C
KOM-73-81493	M18 x 1.5 x 110mm	HEX HEAD BOLT	14C
14-5C-73-20004	M22 x 1.5 x 105mm	HEX HEAD BOLT	14-5C
15C-73-73405	3/4" UNF x 3.500"	12 POINT BOLT	15C
15C-73-76818	M20 x 2.5 x 90mm	12 POINT BOLT	15C

www.hardyspicer.com.au

Document No:	HSDSCAT
Issue:	8
Issue Date:	01/07/17